



HILTI HSA EXPANSION ANCHOR

ETA-11/0374 (27.10.2023)



[English](#) 2-20

[Deutsch](#) 21-39

[Polish](#) 40-58

Approval body for construction products
and types of construction

Bautechnisches Prüfamt

An institution established by the Federal and
Laender Governments



European Technical Assessment

ETA-11/0374
of 27 October 2023

English translation prepared by DIBt - Original version in German language

General Part

Technical Assessment Body issuing the
European Technical Assessment:

Deutsches Institut für Bautechnik

Trade name of the construction product

Hilti metal expansion anchor HSA

Product family
to which the construction product belongs

Mechanical fastener for use in uncracked concrete

Manufacturer

Hilti AG
BU Anchors
Feldkircherstraße 100
9494 SCHAAN
FÜRSTENTUM LIECHTENSTEIN

Manufacturing plant

Hilti Werke

This European Technical Assessment
contains

19 pages including 3 annexes which form an integral part
of this assessment

This European Technical Assessment is
issued in accordance with Regulation (EU)
No 305/2011, on the basis of

330232-01-0601, Edition 05/2021

This version replaces

ETA-11/0374 issued on 3 November 2022

The European Technical Assessment is issued by the Technical Assessment Body in its official language. Translations of this European Technical Assessment in other languages shall fully correspond to the original issued document and shall be identified as such.

Communication of this European Technical Assessment, including transmission by electronic means, shall be in full. However, partial reproduction may only be made with the written consent of the issuing Technical Assessment Body. Any partial reproduction shall be identified as such.

This European Technical Assessment may be withdrawn by the issuing Technical Assessment Body, in particular pursuant to information by the Commission in accordance with Article 25(3) of Regulation (EU) No 305/2011.

Specific Part

1 Technical description of the product

The Hilti metal expansion anchor HSA is a torque-controlled expansion fastener which is placed into a drilled hole and anchored by torque-controlled expansion.

The product description is given in Annex A.

2 Specification of the intended use in accordance with the applicable European Assessment Document

The performances given in Section 3 are only valid if the anchor is used in compliance with the specifications and conditions given in Annex B.

The verifications and assessment methods on which this European Technical Assessment is based lead to the assumption of a working life of the anchor of at least 50 years. The indications given on the working life cannot be interpreted as a guarantee given by the producer, but are to be regarded only as a means for choosing the right products in relation to the expected economically reasonable working life of the works.

3 Performance of the product and references to the methods used for its assessment

3.1 Mechanical resistance and stability (BWR 1)

Essential characteristic	Performance
Characteristic resistance to tension load (static and quasi-static loading) Method A	See Annex B3 and C1
Characteristic resistance to shear load (static and quasi-static loading)	See Annex C2
Displacements	See Annex C3
Characteristic resistance and displacements for seismic performance categories C1 and C2	No performance assessed

3.2 Safety in case of fire (BWR 2)

Essential characteristic	Performance
Reaction to fire	Class A1
Resistance to fire	No performance assessed

3.3 Aspects of durability linked with the Basic Works Requirements

Essential characteristic	Performance
Durability	See Annex B1

4 Assessment and verification of constancy of performance (AVCP) system applied, with reference to its legal base

In accordance with the European Assessment Document EAD 330232-01-0601 the applicable European legal act is: [96/582/EC].

The system to be applied is: 1

English translation prepared by DIBt

5 Technical details necessary for the implementation of the AVCP system, as provided for in the applicable EAD

Technical details necessary for the implementation of the AVCP system are laid down in the control plan deposited with Deutsches Institut für Bautechnik.

Issued in Berlin on 27 October 2023 by Deutsches Institut für Bautechnik

Dipl.-Ing. Beatrix Wittstock
Head of Section

beglaubigt:
Ziegler

Installed condition

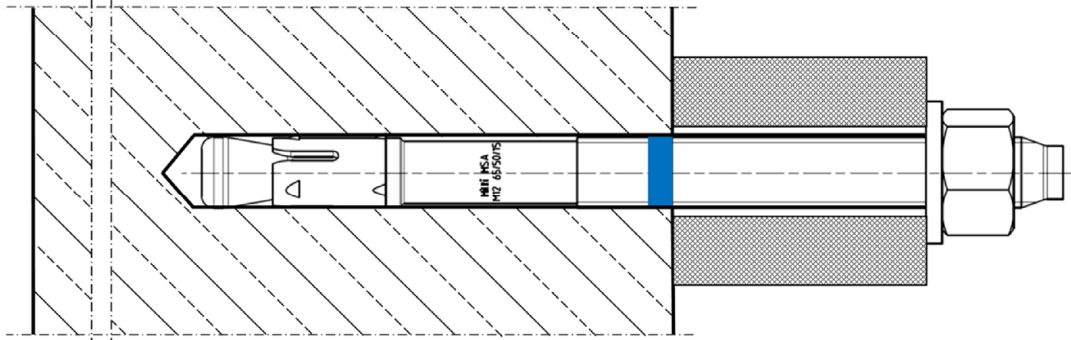

Hilti metal expansion anchor HSA

Product description
Installed condition

Annex A1

Product description: Hilti metal expansion anchor HSA, HSA-BW, HSA-F, HSA-R2 and HSA-R

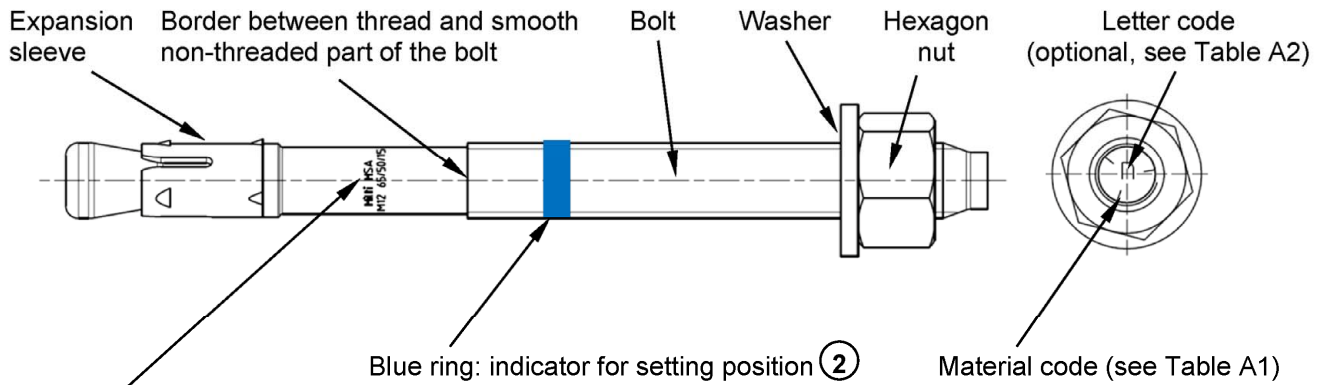



Marking:

Hilti HSA M... $t_{fix,1}/t_{fix,2}/t_{fix,3}$

Brand and metal expansion anchor type as well as metal expansion anchor size and max. fixture thicknesses $t_{fix,1}/t_{fix,2}/t_{fix,3}$

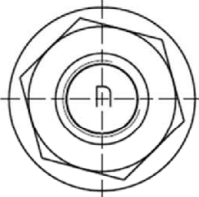
Table A1: Material code for identification of different materials

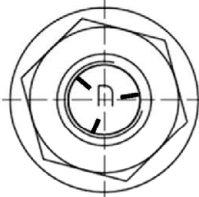
	HSA, HSA-BW, HSA-F	HSA-R2	HSA-R
Material code	 <p>Letter code without mark</p>	 <p>Letter code with two marks</p>	 <p>Letter code with three marks</p>

Hilti metal expansion anchor HSA

Product description

Product marking and material code for identification of metal expansion anchor

Annex A2

Table A2: Letter code for identification of maximum fixture thickness (optional)¹⁾

Size	M6	M8	M10	M12	M16	M20
	$t_{fix,1}/t_{fix,2}/t_{fix,3}$	$t_{fix,1}/t_{fix,2}/t_{fix,3}$	$t_{fix,1}/t_{fix,2}/t_{fix,3}$	$t_{fix,1}/t_{fix,2}/t_{fix,3}$	$t_{fix,1}/t_{fix,2}/t_{fix,3}$	$t_{fix,1}/t_{fix,2}/t_{fix,3}$
	[mm]/[mm]/[mm]	[mm]/[mm]/[mm]	[mm]/[mm]/[mm]	[mm]/[mm]/[mm]	[mm]/[mm]/[mm]	[mm]/[mm]/[mm]
<u>z</u>	5/-/-	5/-/-	5/-/-	5/-/-	5/-/-	5/-/-
<u>y</u>	10/-/-	10/-/-	10/-/-	10/-/-	10/-/-	10/-/-
<u>x</u>	15/5/-	15/5/-	15/5/-	15/-/-	15/-/-	15/-/-
<u>w</u>	20/10/-	20/10/-	20/10/-	20/5/-	20/5/-	20/-/-
<u>v</u>	25/15/-	25/15/-	25/15	25/10/-	25/10/-	25/-/-
<u>u</u>	30/20/-	30/20/-	30/20/-	30/15/-	30/15/-	30/5/-
t	35/25/5	35/25/-	35/25/-	35/20/-	35/20/-	35/10/-
<u>s</u>	40/30/10	40/30/-	40/30/-	40/25/-	40/25/-	40/15/-
r	45/35/15	45/35/5	45/35/5	45/30/-	45/30/-	45/20/5
<u>q</u>	50/40/20	50/40/10	50/40/10	50/35/-	50/35/-	50/25/10
<u>p</u>	55/45/25	55/45/15	55/45/15	55/40/5	55/40/-	55/30/15
<u>o</u>	60/50/30	60/50/20	60/50/20	60/45/10	60/45/5	60/35/20
n	65/55/35	65/55/25	65/55/25	65/50/15	65/50/10	65/40/25
m	70/60/40	70/60/30	70/60/30	70/55/20	70/55/15	70/45/30
<u>l</u>	75/65/45	75/65/35	75/65/35	75/60/25	75/60/20	75/50/35
<u>k</u>	80/70/50	80/70/40	80/70/40	80/65/30	80/65/25	80/55/40
<u>i</u>	85/75/55	85/75/45	85/75/45	85/70/35	85/70/30	85/60/45
<u>i</u>	90/80/60	90/80/50	90/80/50	90/75/40	90/75/35	90/65/50
h	95/85/65	95/85/55	95/85/55	95/80/45	95/80/40	95/70/55
g	100/90/70	100/90/60	100/90/60	100/85/50	100/85/45	100/75/60
f	105/95/75	105/95/65	105/95/65	105/90/55	105/90/50	105/80/65
e	110/100/80	110/100/70	110/100/70	110/95/60	110/95/55	110/85/70
d	115/105/85	115/105/75	115/105/75	115/100/65	115/100/60	115/90/75
<u>c</u>	120/110/90	120/110/80	120/110/80	125/110/75	120/105/65	120/95/80
b	125/115/95	125/115/85	125/115/85	135/120/85	125/110/70	125/100/85
a	130/120/100	130/120/90	130/120/90	145/130/95	135/120/80	130/105/90
aa	-	-	-	155/140/105	145/130/90	-
ab	-	-	-	165/150/115	155/140/100	-
ac	-	-	-	175/160/125	165/150/110	-
ad	-	-	-	180/165/130	190/175/135	-
ae	-	-	-	230/215/180	240/225/185	-
af	-	-	-	280/265/230	290/275/235	-
ag	-	-	-	330/315/280	340/325/285	-

¹⁾ Anchor length in bold is standard item. For selection of other anchor lengths, check availability of the items.

Hilti metal expansion anchor HSA

Product description

Letter code for identification of metal expansion anchor

Annex A3

Table A3: Materials

Designation	Material
HSA, HSA-BW	
Expansion sleeve	M6: Stainless steel A2 according to EN 10088-1:2014 M8 – M20: Carbon steel, galvanized
Bolt	Carbon steel, galvanized, rupture elongation ($l_0 = 5d$) > 8 %
Washer	Carbon steel, galvanized
Hexagon nut	Carbon steel, galvanized
HSA-F	
Expansion sleeve	Stainless steel A2 according to EN 10088-1:2014
Bolt	Hot-dip galvanized, rupture elongation ($l_0 = 5d$) > 8%
Washer	Hot-dip galvanized
Hexagon nut	Hot-dip galvanized
HSA-R2 (stainless steel) Corrosion resistance class II according to EN 1993-1-4:2006+A1:2015	
Expansion sleeve	Stainless steel A2 according to EN 10088-1:2014
Bolt	Stainless steel according to EN 10088-1:2014, coated, rupture elongation ($l_0 = 5d$) > 8%
Washer	Stainless steel A2
Hexagon nut	Stainless steel A2, coated
HSA-R (stainless steel) Corrosion resistance class III according to EN 1993-1-4:2006+A1:2015	
Expansion sleeve	Stainless steel A2 according to EN 10088-1:2014
Bolt	Stainless steel according to EN 10088-1:2014, coated, rupture elongation ($l_0 = 5d$) > 8%
Washer	Stainless steel A4
Hexagon nut	Stainless steel A4, coated

Hilti metal expansion anchor HSA

Product description
Materials

Annex A4

Table A4: Dimensions of Hilti metal expansion anchor HSA, HSA-BW, HSA-F, HSA-R2 and HSA-R

Size	M6	M8	M10	M12	M16	M20
Minimum inner diameter of washer d_1 [mm]	6,4	8,4	10,5	13	17	21
Minimum outer diameter of washer d_w [mm]	12	16	20	24	30	37
Minimum thickness of washer h [mm]	1,6	1,6	2	2,5	3	3

Figure A1: Hilti metal expansion anchor HSA, HSA-F, HSA-R2, HSA-R



Figure A2: Hilti metal expansion anchor HSA-BW

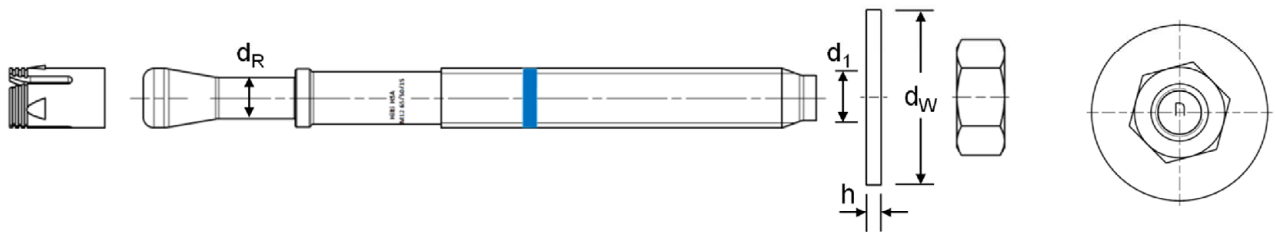

Hilti metal expansion anchor HSA

Product description
Dimensions

Annex A5

Specifications of intended use

Anchorage subject to:

- Static and quasi static loading.

Base materials:

- Compacted reinforced or unreinforced normal weight concrete without fibres according to EN 206:2013+A1:2016.
- Strength classes C20/25 to C50/60 according to EN 206:2013+A1:2016.
- uncracked concrete.

Use conditions (Environmental conditions):

- Structures subject to dry internal conditions (all materials).
- For all other conditions according EN 1993-1-4:2006+A1:2015 corresponding to corrosion resistance classes Annex A, Table A3 (stainless steel).

Design:

- Anchorages are designed under the responsibility of an engineer experienced in anchorages and concrete work.
- Verifiable calculation notes and drawings are prepared taking account of the loads to be anchored. The position of the metal expansion anchor is indicated on the design drawings (e. g. position of the metal expansion anchor relative to reinforcement or to supports, etc.).
- Anchorages under static or quasi static loading are designed in accordance with: EN 1992-4:2018 and EOTA Technical Report TR 055:2018.

Installation:

- Anchor installation carried out by appropriately qualified personnel and under the supervision of the person responsible for technical matters of the site.
- The metal expansion anchor may only be set once.

Hilti metal expansion anchor HSA	Annex B1
Intended use Specifications	

Table B1: Drilling technique



Size		M6	M8	M10	M12	M16	M20
Hammer drilling (HD)					✓		
Hammer drilling with Hilti hollow drill bit TE-CD/YD ... drilling system (HDB)		-	-	-		✓	
Diamond coring (DD) with DD 30-W coring tool and C+ ... SPX-T (abrasive) core bits		-	-		✓		

Table B2: Drill hole cleaning



<p>Manual cleaning (MC): Hilti hand pump for blowing out drill holes.</p>	
<p>Automatic cleaning (AC): Cleaning is performed during drilling with Hilti TE-CD and TE-YD drilling system including vacuum cleaner.</p>	

Table B3: Setting alternatives



Size	M6	M8	M10	M12	M16	M20
Hammer setting				✓		
Machine setting (impact screwdriver with setting tool)	-			✓		

Hilti metal expansion anchor HSA

Intended use
Installation methods

Annex B2

Table B4: Methods for application of torque moment

Size		M6	M8	M10	M12	M16	M20
Torque wrench					✓		
Setting tool S-TB HSA ... with impact screwdriver Hilti SIW ... ¹⁾		-			✓		-
		-	14-A / 22-A / 6AT-A22			22T-A	-
Setting speed	HSA, HSA-BW, HSA-F	-	I	I	III	.. ²⁾	
	HSA-R2, HSA-R	-	III				-
Setting time t_{set}	[sec.]	-	4				-
Machine torqueing with Hilti SIW impact wrench and SI-AT adaptive torque module							
• SIW 4AT-22 with SI-AT-22 ³⁾	HSA, HSA-BW	-	✓	✓	✓	✓	-
• SIW 6AT-22 with SI-AT-22 ³⁾	HSA-R2, HSA-R	-	-	✓	✓	✓	✓

¹⁾ see Table B5 for battery state of charge depending on the ambient temperature.

²⁾ Impact screwdriver operates with fixed speed.

³⁾ Equivalent combination of Hilti SIW + SI-AT tool, compatible to this anchor type, may be used

Table B5: Battery state of charge of impact screwdriver

Ambient temperature		≤ +5 °C	+5 to +10 °C	≥ +10 °C
Battery state of charge	low	-	-	-
	middle	-	-	✓
	high	-	✓	✓

Hilti metal expansion anchor HSA

Intended use
Installation methods

Annex B3

Table B6: Installation parameters

Size	M6			M8			M10			M12			M16			M20																				
Nominal diameter of drill bit d_0 [mm]	6			8			10			12			16			20																				
Maximum cutting diameter of drill bit d_{cut} [mm]	6,4			8,45			10,45			12,5			16,5			20,55																				
Maximum diameter of clearance hole in the fixture d_f [mm]	7			9			12			14			18			22																				
Width across flats SW [mm]	10			13			17			19			24			30																				
Setting position	①	②	③	①	②	③	①	②	③	①	②	③	①	②	③	①	②	③																		
Minimum thickness of concrete member h_{min} [mm]	100			120			100			120			100			140			180			140			160			180			160			220		
Nominal embedment depth h_{nom} [mm]	37	47	67	39	49	79	50	60	90	64	79	114	77	92	132	90	115	130																		
Effective embedment depth h_{ef} [mm]	30	40	60	30	40	70	40	50	80	50	65	100	65	80	120	75	100	115																		
Drill hole depth (HD, HDB) $h_1 \geq$ [mm]	42	52	72	44	54	84	55	65	95	72	87	122	85	100	140	98	123	138																		
Drill hole depth (DD) $h_1 \geq$ [mm]	-			-			58	68	98	72	87	122	85	100	140	98	123	138																		
Standard installation torque moment																																				
Installation torque moment T_{inst} [Nm]	5			15 ¹⁾²⁾			25 ¹⁾²⁾			50 ¹⁾²⁾			80 ¹⁾²⁾			200																				
Minimum spacing s_{min} [mm]	35			35			50			70			90			195	175																			
Minimum edge distance c_{min} [mm]	35			40	35	50	40	70	65	55	80	75	70	130	120																					
Maximum installation torque moment																																				
Maximum installation torque moment T_{max} [Nm]	-			20			35			80			150			250																				
Minimum spacing s_{min} [mm]	-			35			40			50			80			120																				
Minimum edge distance c_{min} [mm]	-			100			150			190			200			225																				

1) Alternatively, the metal expansion anchor can be tightened with an impact screwdriver in combination with a setting tool with the required setting time (see Annex B2).

2) Alternatively, the metal expansion anchor can be tightened with an impact screwdriver in combination with module (see Annex B2).

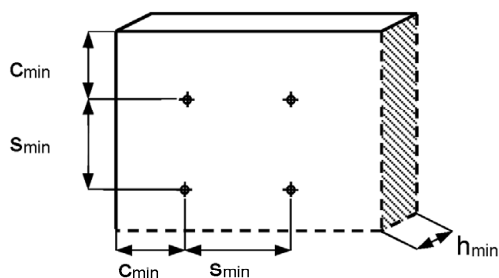

Hilti metal expansion anchor HSA

Intended use
Installation parameters

Annex B4

Figure B1: Constant anchor length with various fixture thicknesses t_{fix} and corresponding setting position

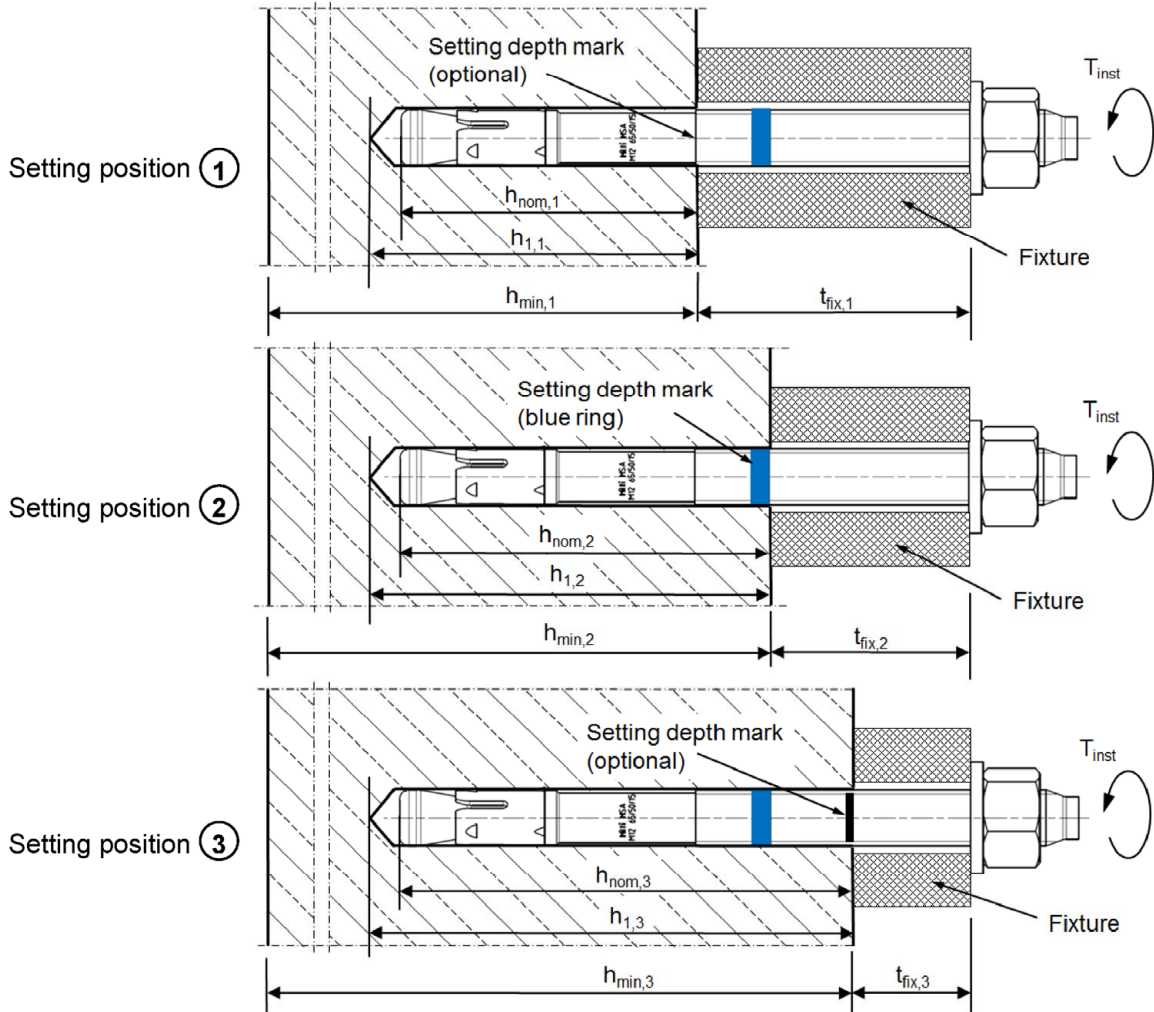

Hilti metal expansion anchor HSA

Intended use
Installation parameters

Annex B5

Figure B2: Various anchor lengths for different setting positions and corresponding fixture thickness t_{fix}

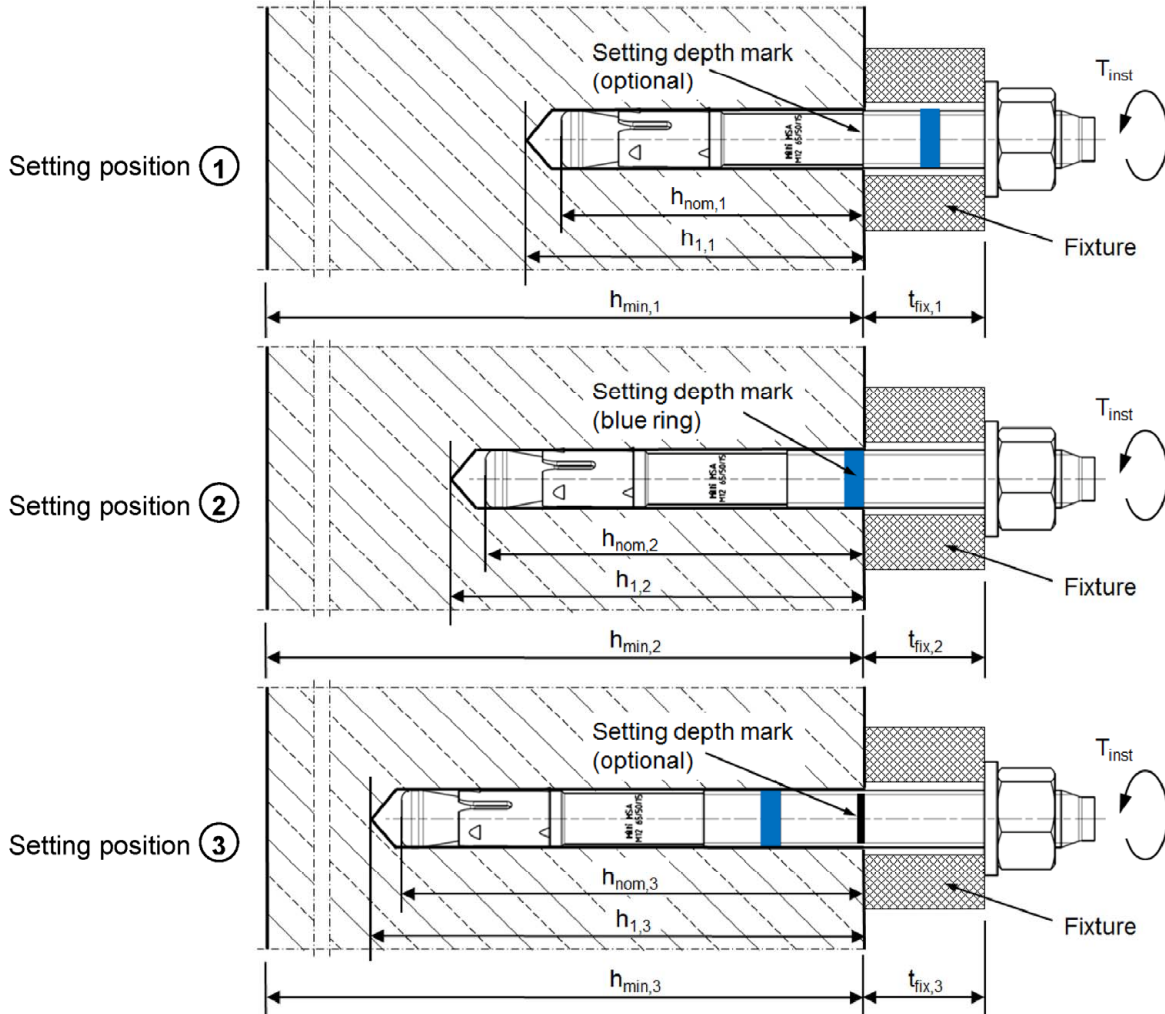

Table B7: Checking setting position

Setting position	Pre-setting	Through setting
①	with letter code "a" to "z" (see Table A2): $h_{nom,1}$ is reached when the non-threaded part of the bolt is completely below the concrete surface. with letter code "aa" to "ag" (see Table A2) and without letter code: $h_{nom,1}$ has to be measured and marked by the installer.	$h_{nom,1}$, $h_{nom,2}$ or $h_{nom,3}$ is reached when the present thickness of the fixture t_{fix} and the maximum thickness of the fixture $t_{fix,1}/t_{fix,2}/t_{fix,3}$ given by the anchor is identical.
②	$h_{nom,2}$ is reached when the blue ring is completely below the concrete surface.	If the present thickness of the fixture t_{fix} is smaller than the maximum thickness of the fixture $t_{fix,1}/t_{fix,2}/t_{fix,3}$ given by the anchor
③	$h_{nom,3}$ has to be measured and marked by the installer.	<ul style="list-style-type: none"> position of washer and hexagon nut has to be adjusted or drill hole depth h_1 has to be increased.

Hilti metal expansion anchor HSA

Intended use
Installation parameters

Annex B6

Installation instruction

Hole drilling and cleaning (see Table B1, Table B2 and Table B6)

a) Hammer drilling (HD) with manual cleaning (MC)

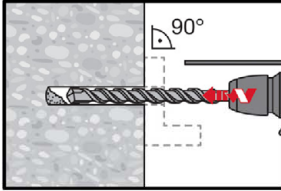

b) Hammer drilling with Hilti hollow drill bit (HDB) with automatic cleaning (AC)

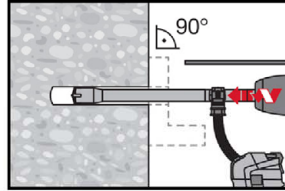

c) Diamond coring (DD) with manual cleaning (MC)

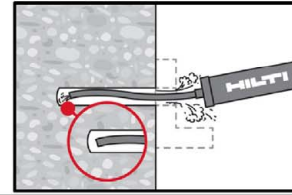
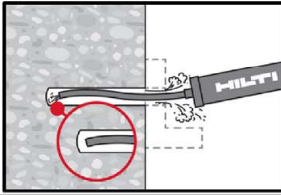
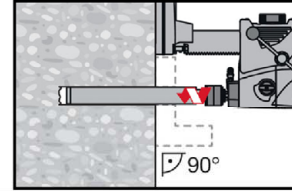

Anchor setting (see Table B3)

a) Hammer setting

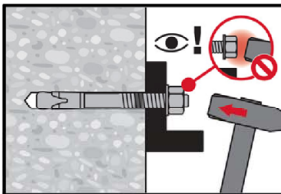

b) Machine setting (impact screwdriver with setting tool)

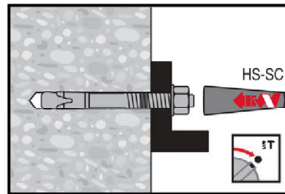

Check setting (see Table B7)

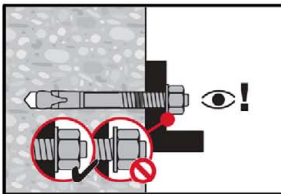

Anchor torquing (see Table B4 and Table B5)

a) Torque wrench

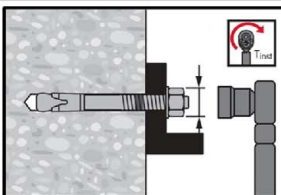

b) Impact screwdriver with setting tool

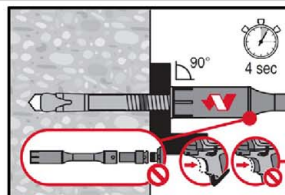

c) Impact screwdriver with module

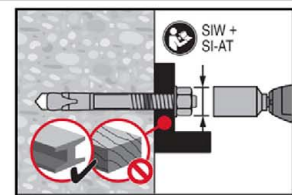

Check installation

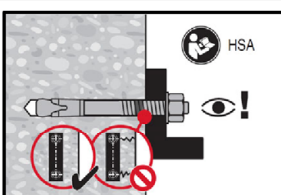

Hilti metal expansion anchor HSA

Intended use
Installation instructions

Annex B7

Table C1: Characteristic resistance under tension load in uncracked concrete

Size		M6			M8			M10			M12			M16			M20		
Setting position		①	②	③	①	②	③	①	②	③	①	②	③	①	②	③	①	②	③
Effective anchorage depth	h_{ef} [mm]	30 ¹⁾	40	60	30 ¹⁾	40	70	40	50	80	50	65	100	65	80	120	75	100	115
Steel failure																			
Partial safety factor	$\gamma_{Ms}^{2)}$ [-]	1,4																	
HSA, HSA-BW																			
Characteristic resistance	$N_{Rk,s}$ [kN]	9,0			16,5			28,0			41,4			82,6			124		
HSA-F																			
Characteristic resistance	$N_{Rk,s}$ [kN]	9,5			15,9			27,0			40,4			80,1			3)		
HSA-R2, HSA-R																			
Characteristic resistance	$N_{Rk,s}$ [kN]	12,2			18,3			35,6			44,6			90,5			97,6		
Pullout failure																			
Installation safety factor	γ_{inst} [-]	1,0																	
Characteristic resistance	$N_{Rk,p}$ [kN]	6	7,5	9	8,1	12,4	16	12,4	17,4	25	17,4	25,8	35	25,8	35,2	50	32	49,2	60,7
Increasing factor ψ_c for $N_{Rk,p}$	C20/25 [-]	1,00																	
	C30/37 [-]	1,22																	
	C40/50 [-]	1,41																	
	C50/60 [-]	1,55																	
Concrete cone and splitting failure																			
Installation safety factor	γ_{inst} [-]	1,0																	
Factor for uncracked concrete	$k_{ucr,N}$ [-]	11,0																	
Factor for cracked concrete	$k_{cr,N}$ [-]	3)																	
Spacing	$s_{cr,N}$ [mm]	$3 \cdot h_{ef}$																	
	$s_{cr,sp}$ [mm]	100	120	130	130	180	200	190	210	290	200	250	310	230	280	380	260	370	400
Edge distance	$c_{cr,N}$ [mm]	$1,5 \cdot h_{ef}$																	
	$c_{cr,sp}$ [mm]	50	60	65	65	90	100	95	105	145	100	125	155	115	140	190	130	185	200
Characteristic resistance	$N^0_{Rk,sp}$ [kN]	6	7,5	9	8,1	12,4	16	12,4	17,4	25	17,4	25,8	35	25,8	35,2	50	32	49,2	60,7

¹⁾ Use is restricted to anchoring of statically indeterminate structural components and dry internal conditions.

²⁾ In absence of other national regulations.

³⁾ No performance assessed.

Hilti metal expansion anchor HSA

Performance
Characteristic resistance under tension load in uncracked concrete

Annex C1

Table C2: Characteristic resistance under shear load in uncracked concrete

Size	M6			M8			M10			M12			M16			M20		
Setting position	①	②	③	①	②	③	①	②	③	①	②	③	①	②	③	①	②	③
Effective anchorage depth h_{ef} [mm]	30 ¹⁾	40	60	30 ¹⁾	40	70	40	50	80	50	65	100	65	80	120	75	100	115
Steel failure without lever arm																		
Partial safety factor $\gamma_{Ms}^{(2)}$ [-]	1,25																	
Ductility factor k_7 [-]	1,0																	
HSA, HSA-BW																		
Characteristic resistance $V_{Rk,s}^0$ [kN]	6,5			10,6			18,9			29,5			51,0			85,8		
HSA-F																		
Characteristic resistance $V_{Rk,s}^0$ [kN]	6,5			10,6			18,9			29,5			51,0			3)		
HSA-R2, HSA-R																		
Characteristic resistance $V_{Rk,s}^0$ [kN]	7,2			12,3			22,6			29,3			56,5			91,9		
Steel failure with lever arm																		
Partial safety factor $\gamma_{Ms}^{(2)}$ [-]	1,25																	
Ductility factor k_7 [-]	1,0																	
HSA, HSA-BW																		
Characteristic resistance $M_{Rk,s}^0$ [Nm]	9,9			21,7			48,6			91,7			216			454		
HSA-F																		
Characteristic resistance $M_{Rk,s}^0$ [Nm]	9,9			21,7			48,6			91,7			216			3)		
HSA-R2, HSA-R																		
Characteristic resistance $M_{Rk,s}^0$ [Nm]	9,9			21,0			48,6			76,0			200			406		
Concrete pry-out failure																		
Installation safety factor γ_{inst} [-]	1,0																	
Pry-out factor k_8 [-]	1	2	1	1,5	2	2,4	2	2,9	2	3,5								
Concrete edge failure																		
Installation safety factor γ_{inst} [-]	1,0																	
Effective length of anchor l_f [mm]	30	40	60	30	40	70	40	50	80	50	65	100	65	80	120	75	100	115
Effective outside diameter of anchor d_{nom} [mm]	6			8			10			12			16			20		

¹⁾ Use is restricted to anchoring of statically indeterminate structural components and dry internal conditions.

²⁾ In absence of other national regulations.

³⁾ No performance assessed.

Hilti metal expansion anchor HSA

Performance
Characteristic resistance under shear load in uncracked concrete

Annex C2

Table C3: Displacements under tension and shear loads in uncracked concrete

Size	M6			M8			M10			M12			M16			M20		
Setting position	①	②	③	①	②	③	①	②	③	①	②	③	①	②	③	①	②	③
Effective anchorage depth h_{ef} [mm]	30	40	60	30	40	70	40	50	80	50	65	100	65	80	120	75	100	115
Displacements under tension loads																		
Tension force N [kN]	2,9	3,6	4,3	4,0	6,1	7,6	6,1	8,5	11,9	8,5	12,6	16,7	12,6	17,2	23,8	16,6	25,1	30,8
Corresponding displacement δ_{N0} [mm]	0,2	0,6	1,0	0,2	1,2	1,8	0,4	1,1	2,0	0,3	1,4	2,3	0,4	1,3	2,1	0,1	0,8	1,9
Corresponding displacement $\delta_{N\infty}$ [mm]	0,6	1,0	1,4	0,6	1,6	2,2	0,8	1,5	2,4	0,7	1,8	2,7	0,8	1,7	2,5	0,5	1,2	2,3
Displacements under shear loads																		
Shear force V [kN]	3,7			6,1			10,8			16,7			29,1			49,0		
Corresponding displacement δ_{V0} [mm]	1,6			1,9			2,0			2,1			2,2			2,3		
Corresponding displacement $\delta_{V\infty}$ [mm]	2,4			2,9			3,0			3,2			3,3			3,5		

Hilti metal expansion anchor HSA

Performance

Displacement under tension and shear loads in uncracked concrete

Annex C3

Zulassungsstelle für Bauprodukte und Bauarten

Bautechnisches Prüfamts

Eine vom Bund und den Ländern
gemeinsam getragene Anstalt des öffentlichen Rechts



Europäische Technische Bewertung

ETA-11/0374
vom 27. Oktober 2023

Allgemeiner Teil

Technische Bewertungsstelle, die die Europäische Technische Bewertung ausstellt

Handelsname des Bauprodukts

Produktfamilie,
zu der das Bauprodukt gehört

Hersteller

Herstellungsbetrieb

Diese Europäische Technische Bewertung enthält

Diese Europäische Technische Bewertung wird ausgestellt gemäß der Verordnung (EU) Nr. 305/2011, auf der Grundlage von

Diese Fassung ersetzt

Deutsches Institut für Bautechnik

Hilti Metallspreizanker HSA

Mechanischer Dübel zur Verankerung im ungerissenen Beton

Hilti AG
BU Anchors
Feldkircherstraße 100
9494 SCHAAN
FÜRSTENTUM LIECHTENSTEIN

Hilti Werke

19 Seiten, davon 3 Anhänge, die fester Bestandteil dieser Bewertung sind.

330232-01-0601 Edition 05/2021

ETA-11/0374 vom 3. November 2022

Die Europäische Technische Bewertung wird von der Technischen Bewertungsstelle in ihrer Amtssprache ausgestellt. Übersetzungen dieser Europäischen Technischen Bewertung in andere Sprachen müssen dem Original vollständig entsprechen und müssen als solche gekennzeichnet sein.

Diese Europäische Technische Bewertung darf, auch bei elektronischer Übermittlung, nur vollständig und ungekürzt wiedergegeben werden. Nur mit schriftlicher Zustimmung der ausstellenden Technischen Bewertungsstelle kann eine teilweise Wiedergabe erfolgen. Jede teilweise Wiedergabe ist als solche zu kennzeichnen.

Die ausstellende Technische Bewertungsstelle kann diese Europäische Technische Bewertung widerrufen, insbesondere nach Unterrichtung durch die Kommission gemäß Artikel 25 Absatz 3 der Verordnung (EU) Nr. 305/2011.

Besonderer Teil

1 Technische Beschreibung des Produkts

Der Hilti Metallspreizanker HSA ist ein Dübel, der in ein Bohrloch gesteckt und kraftkontrolliert verankert wird.

Die Produktbeschreibung ist in Anhang A angegeben.

2 Spezifizierung des Verwendungszwecks gemäß dem anwendbaren Europäischen Bewertungsdokument

Von den Leistungen in Abschnitt 3 kann nur ausgegangen werden, wenn der Dübel entsprechend den Angaben und unter den Randbedingungen nach Anhang B verwendet wird.

Die Prüf- und Bewertungsmethoden, die dieser Europäischen Technischen Bewertung zu Grunde liegen, führen zur Annahme einer Nutzungsdauer des Dübels von mindestens 50 Jahren. Die Angabe der Nutzungsdauer kann nicht als Garantie des Herstellers verstanden werden, sondern ist lediglich ein Hilfsmittel zur Auswahl des richtigen Produkts in Bezug auf die angenommene wirtschaftlich angemessene Nutzungsdauer des Bauwerks.

3 Leistung des Produkts und Angaben der Methoden ihrer Bewertung

3.1 Mechanische Festigkeit und Standsicherheit (BWR 1)

Wesentliches Merkmal	Leistung
Charakteristische Widerstände unter Zugbeanspruchung (statische und quasi-statische Lasten) Methode A	Siehe Anhang B3 und C1
Charakteristische Widerstände unter Querlast (statische und quasi-statische Lasten)	Siehe Anhang C2
Verschiebungen	Siehe Anhang C3
Charakteristischer Widerstand für die seismischen Leistungskategorien C1 und C2	Keine Leistung bewertet

3.2 Brandschutz (BWR 2)

Wesentliches Merkmal	Leistung
Brandverhalten	Klasse A1
Feuerwiderstand	Keine Leistung bewertet

3.3 Aspekte der Dauerhaftigkeit in Bezug auf die Grundanforderungen an Bauwerke

Wesentliches Merkmal	Leistung
Dauerhaftigkeit	Siehe Anhang B1

4 Angewandtes System zur Bewertung und Überprüfung der Leistungsbeständigkeit mit der Angabe der Rechtsgrundlage

Gemäß dem Europäischen Bewertungsdokument EAD 330232-01-0601 gilt folgende Rechtsgrundlage: [96/582/EG].

Folgendes System ist anzuwenden: 1

5 Für die Durchführung des Systems zur Bewertung und Überprüfung der Leistungsbeständigkeit erforderliche technische Einzelheiten gemäß anwendbarem Europäischen Bewertungsdokument

Technische Einzelheiten, die für die Durchführung des Systems zur Bewertung und Überprüfung der Leistungsbeständigkeit notwendig sind, sind Bestandteil des Prüfplans, der beim Deutschen Institut für Bautechnik hinterlegt ist.

Ausgestellt in Berlin am 27. Oktober 2023 vom Deutschen Institut für Bautechnik

Dipl.-Ing. Beatrix Wittstock
Referatsleiterin

Beglaubigt
Ziegler

Einbauzustand

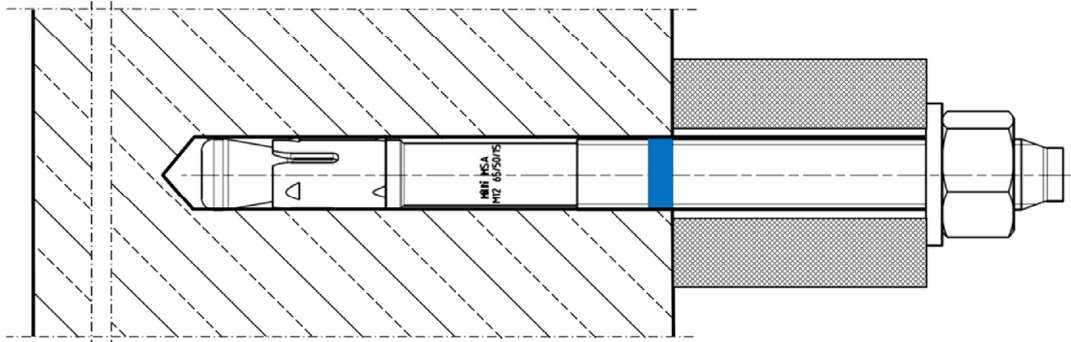

Hilti Metallspreizanker HSA

Produktbeschreibung
Einbauzustand

Anhang A1

Produktbeschreibung: Hilti Metallspreizanker HSA, HSA-BW, HSA-F, HSA-R2 und HSA-R

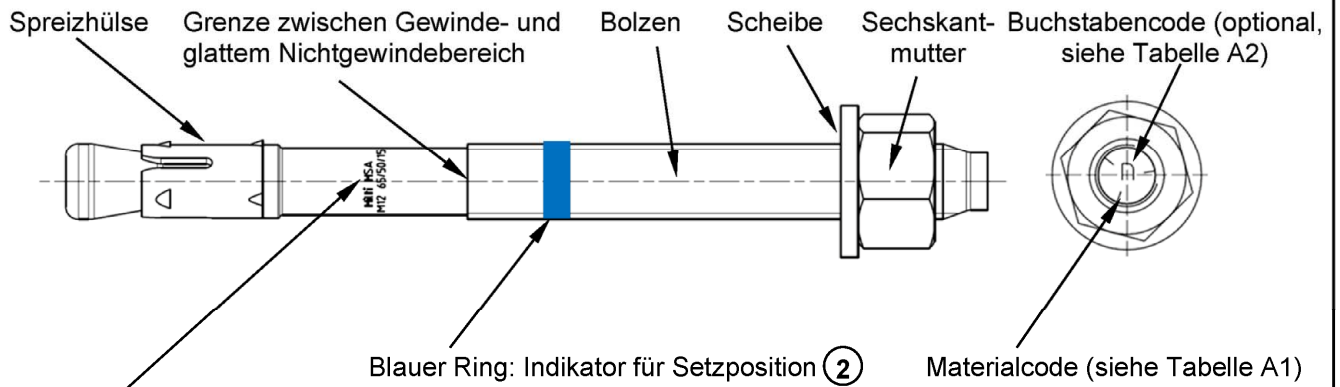

Kennzeichnung:

Hilti HSA M... $t_{fix,1}/t_{fix,2}/t_{fix,3}$

Hersteller und Typ des Metallspreizankers sowie Durchmesser des Metallspreizankers und maximale Dicke der Anbauteile $t_{fix,1}/t_{fix,2}/t_{fix,3}$

Tabelle A1: Materialcode zur Identifikation der unterschiedlichen Werkstoffe

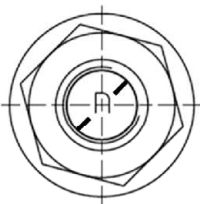
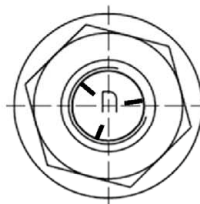
	HSA, HSA-BW, HSA-F	HSA-R2	HSA-R
Materialcode	 Buchstabencode ohne Markierung	 Buchstabencode mit zwei Markierungen	 Buchstabencode mit drei Markierungen

Hilti Metallspreizanker HSA

Produktbeschreibung

Kennzeichnung und Materialcode zur Identifikation des Metallspreizankers

Anhang A2

Tabelle A2: Buchstabencode zur Identifikation der maximalen Dicke der Anbauteile (optional)¹⁾

Größe	M6	M8	M10	M12	M16	M20
	$t_{\text{fix},1}/t_{\text{fix},2}/t_{\text{fix},3}$	$t_{\text{fix},1}/t_{\text{fix},2}/t_{\text{fix},3}$	$t_{\text{fix},1}/t_{\text{fix},2}/t_{\text{fix},3}$	$t_{\text{fix},1}/t_{\text{fix},2}/t_{\text{fix},3}$	$t_{\text{fix},1}/t_{\text{fix},2}/t_{\text{fix},3}$	$t_{\text{fix},1}/t_{\text{fix},2}/t_{\text{fix},3}$
	[mm]/[mm]/[mm]	[mm]/[mm]/[mm]	[mm]/[mm]/[mm]	[mm]/[mm]/[mm]	[mm]/[mm]/[mm]	[mm]/[mm]/[mm]
z	5/-/-	5/-/-	5/-/-	5/-/-	5/-/-	5/-/-
y	10/-/-	10/-/-	10/-/-	10/-/-	10/-/-	10/-/-
x	15/5/-	15/5/-	15/5/-	15/-/-	15/-/-	15/-/-
w	20/10/-	20/10/-	20/10/-	20/5/-	20/5/-	20/-/-
v	25/15/-	25/15/-	25/15	25/10/-	25/10/-	25/-/-
u	30/20/-	30/20/-	30/20/-	30/15/-	30/15/-	30/5/-
t	35/25/5	35/25/-	35/25/-	35/20/-	35/20/-	35/10/-
s	40/30/10	40/30/-	40/30/-	40/25/-	40/25/-	40/15/-
r	45/35/15	45/35/5	45/35/5	45/30/-	45/30/-	45/20/5
q	50/40/20	50/40/10	50/40/10	50/35/-	50/35/-	50/25/10
p	55/45/25	55/45/15	55/45/15	55/40/5	55/40/-	55/30/15
o	60/50/30	60/50/20	60/50/20	60/45/10	60/45/5	60/35/20
n	65/55/35	65/55/25	65/55/25	65/50/15	65/50/10	65/40/25
m	70/60/40	70/60/30	70/60/30	70/55/20	70/55/15	70/45/30
l	75/65/45	75/65/35	75/65/35	75/60/25	75/60/20	75/50/35
k	80/70/50	80/70/40	80/70/40	80/65/30	80/65/25	80/55/40
j	85/75/55	85/75/45	85/75/45	85/70/35	85/70/30	85/60/45
i	90/80/60	90/80/50	90/80/50	90/75/40	90/75/35	90/65/50
h	95/85/65	95/85/55	95/85/55	95/80/45	95/80/40	95/70/55
g	100/90/70	100/90/60	100/90/60	100/85/50	100/85/45	100/75/60
f	105/95/75	105/95/65	105/95/65	105/90/55	105/90/50	105/80/65
e	110/100/80	110/100/70	110/100/70	110/95/60	110/95/55	110/85/70
d	115/105/85	115/105/75	115/105/75	115/100/65	115/100/60	115/90/75
c	120/110/90	120/110/80	120/110/80	125/110/75	120/105/65	120/95/80
b	125/115/95	125/115/85	125/115/85	135/120/85	125/110/70	125/100/85
a	130/120/100	130/120/90	130/120/90	145/130/95	135/120/80	130/105/90
aa	-	-	-	155/140/105	145/130/90	-
ab	-	-	-	165/150/115	155/140/100	-
ac	-	-	-	175/160/125	165/150/110	-
ad	-	-	-	180/165/130	190/175/135	-
ae	-	-	-	230/215/180	240/225/185	-
af	-	-	-	280/265/230	290/275/235	-
ag	-	-	-	330/315/280	340/325/285	-

¹⁾ Ankerlängen in fett gedruckt entsprechen der Standardlänge. Für die Auswahl anderer Ankerlängen ist die Verfügbarkeit zu prüfen.

Hilti Metallpreisanker HSA

Produktbeschreibung
Buchstabencode zur Identifikation des Metallpreisankers

Anhang A3

Tabelle A3: Werkstoffe

Bezeichnung	Werkstoff
HSA, HSA-BW	
Spreizhülse	M6: Nichtrostender Stahl A2 nach EN 10088-1:2014 M8 – M20: C-Stahl, galvanisch verzinkt
Bolzen	C-Stahl, galvanisch verzinkt, Bruchdehnung ($l_0 = 5d$) > 8 %
Scheibe	C-Stahl, galvanisch verzinkt
Sechskantmutter	C-Stahl, galvanisch verzinkt
HSA-F	
Spreizhülse	Nichtrostender Stahl nach EN 10088-1:2014
Bolzen	Feuerverzinkt, Bruchdehnung ($l_0 = 5d$) > 8 %
Scheibe	Feuerverzinkt
Sechskantmutter	Feuerverzinkt
HSA-R2 (nichtrostender Stahl)	
Korrosionsbeständigkeitsklasse II nach EN 1993-1-4:2006+A1:2015	
Spreizhülse	Nichtrostender Stahl A2 nach EN 10088-1:2014
Bolzen	Nichtrostender Stahl nach EN 10088-1:2014, beschichtet, Bruchdehnung ($l_0 = 5d$) > 8 %
Scheibe	Nichtrostender Stahl A2
Sechskantmutter	Nichtrostender Stahl A2, beschichtet
HSA-R (nichtrostender Stahl)	
Korrosionsbeständigkeitsklasse III nach EN 1993-1-4:2006+A1:2015	
Spreizhülse	Nichtrostender Stahl A2 nach EN 10088-1:2014
Bolzen	Nichtrostender Stahl nach EN 10088-1:2014, beschichtet, Bruchdehnung ($l_0 = 5d$) > 8 %
Scheibe	Nichtrostender Stahl A4
Sechskantmutter	Nichtrostender Stahl A4, beschichtet

Hilti Metallpreisanker HSA

Produktbeschreibung
Werkstoffe

Anhang A4

Tabelle A4: Abmessungen Hilti Metallspreizanker HSA, HSA-BW, HSA-F, HSA-R2 und HSA-R

Größe		M6	M8	M10	M12	M16	M20
Minimaler innerer Durchmesser der Scheibe	d_1 [mm]	6,4	8,4	10,5	13	17	21
Minimaler äußerer Durchmesser der Scheibe	d_w [mm]	12	16	20	24	30	37
Minimale Dicke der Scheibe	h [mm]	1,6	1,6	2	2,5	3	3

Bild A1: Hilti Metallspreizanker HSA, HSA-F, HSA-R2, HSA-R



Bild A2: Hilti Metallspreizanker HSA-BW



Hilti Metallspreizanker HSA

Produktbeschreibung
Abmessungen

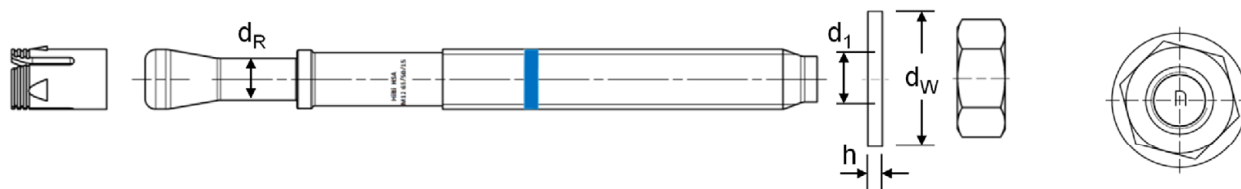
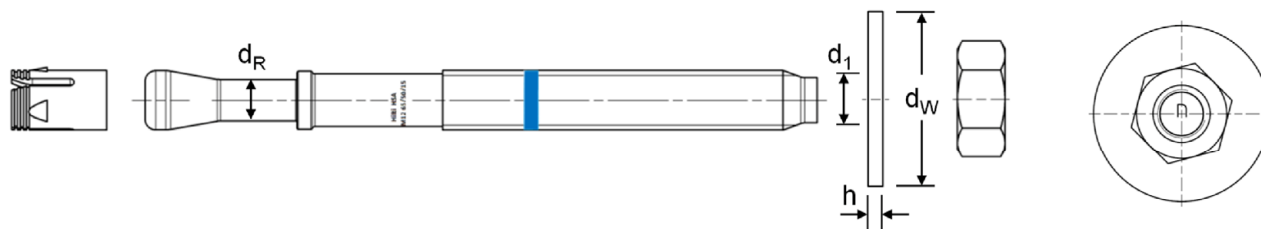
Anhang A4

Angaben zum Verwendungszweck

Beanspruchung der Verankerung:

- Statische und quasi-statische Belastung.

Verankerungsgrund:

- Verdichteter bewehrter oder unbewehrter Normalbeton ohne Fasern nach EN 206:2013+A1:2016.
- Festigkeitsklasse C20/25 bis C50/60 nach EN 206:2013+A1:2016.
- Ungerissener Beton.

Anwendungsbedingungen (Umweltbedingungen):

- In Bauteilen unter den Bedingungen trockener Innenräume (alle Werkstoffe).
- Für alle anderen Umweltbedingungen nach EN 1993-1-4:2006+A1:2015 entsprechend der Korrosionsbeständigkeitsklassen Anhang A, Tabelle A3 (nichtrostender Stahl).

Bemessung:

- Die Befestigungen müssen unter der Verantwortung eines auf dem Gebiet der Verankerungen und des Betonbaus erfahrenen Ingenieurs bemessen werden.
- Unter Berücksichtigung der zu verankernden Lasten sind prüfbare Berechnungen und Konstruktionszeichnungen anzufertigen. Auf den Konstruktionszeichnungen ist die Lage des Metallspreizankers (z. B. Lage des Metallspreizankers zur Bewehrung oder zu den Auflagern usw.) anzugeben.
- Die Bemessung von Verankerungen unter statischer und quasistatischer Belastung erfolgt in Übereinstimmung mit:
EN 1992-4:2018 and EOTA Technical Report TR 055:2018.

Einbau:

- Der Einbau erfolgt durch entsprechend geschultes Personal unter der Aufsicht des Bauleiters.
- Der Metallspreizanker darf nur einmal verwendet werden.

Hilti Metallspreizanker HSA

Verwendungszweck
Spezifikationen

Anhang B1

Tabelle B1: Bohrverfahren



Größe		M6	M8	M10	M12	M16	M20
Hammerbohren (HD)		✓					
Hammerbohren mit Hilti Hohlbohrer TE-CD/YD ... Bohrsystem (HDB)		-	-	-	✓		
Diamantbohrverfahren (DD) mit DD 30- W Diamantbohrgerät und C+ ... SPX-T (abrasive) Bohrkronen		-	-	✓			

Tabelle B2: Bohrlochreinigung



<p>Handreinigung (MC): Zum Ausblasen von Bohrlöchern wird die Hilti-Handausblaspumpe empfohlen.</p>	
<p>Automatische Reinigung (AC): Die Reinigung wird während des Bohrens mit dem Hilti Hohlbohrer TE-CD und TE-YD Bohrsystem inklusive Staubsauger durchgeführt.</p>	

Tabelle B3: Setzalternativen



Größe	M6	M8	M10	M12	M16	M20
Setzen mit Hammer	✓					
Setzen mit Maschine (Schlagschrauber mit Setzwerkzeug)	-	✓				

Hilti Metallspreizanker HSA

Verwendungszweck
Installationsparameter

Anhang B2

Tabelle B4: Methoden zum Aufbringen des Anzugsdrehmomentes

Größe		M6	M8	M10	M12	M16	M20	
Drehmomentschlüssel		✓						
Hilti Setzwerkzeug S-TB HSA ... mit Hilti SIW... Schlagschrauber ¹⁾		✓						-
		-	14-A / 22-A / 6AT-A22			22T-A	-	
Gang	HSA, HSA-BW, HSA-F	-	I	I	III	- ²⁾		
	HSA-R2, HSA-R	-	III				-	
Setzdauer t_{set} [sec.]		-	4				-	
Machinensetzen mit Hilti SIW Schlagschrauber und adaptivem SI-AT Anzugsmodul								
• SIW 4AT-22 with SI-AT-22 ³⁾	HSA, HSA-BW	-	✓	✓	✓	✓	-	
• SIW 6AT-22 with SI-AT-22 ³⁾	HSA-R2, HSA-R	-	-	✓	✓	✓	✓	

¹⁾ siehe Tabelle B5 für den erforderlichen Akkuladestatus in Abhängigkeit von der Umgebungstemperatur.

²⁾ Schlagschrauber verfügt über feste Gangeinstellung.

³⁾ Gleichwertige Kombination aus Hilti SIW + SI-AT tool, die mit diesem Ankertyp kompatibel ist, kann verwendet werden

Tabelle B5: Akkuladestatus des Schlagschraubers

Umgebungstemperatur		≤ +5 °C	+5 bis +10 °C	≥ +10 °C
Akkuladestatus	gering	-	-	-
	mittel	-	-	✓
	hoch	-	✓	✓

Hilti Metallpreisanker HSA

Verwendungszweck
Installationsparameter

Anhang B3

Tabelle B6: Montagekennwerte

Größe	M6	M8	M10	M12	M16	M20												
Bohrerinnendurchmesser d_0 [mm]	6	8	10	12	16	20												
Maximaler Bohrer-schneiden-durchmesser d_{cut} [mm]	6,4	8,45	10,45	12,5	16,5	20,55												
Maximaler Durchmesser des Durchgangslochs im Anbauteil d_f [mm]	7	9	12	14	18	22												
Schlüsselweite SW [mm]	10	13	17	19	24	30												
Setzposition	① ② ③	① ② ③	① ② ③	① ② ③	① ② ③	① ② ③												
Minimale Bauteildicke h_{min} [mm]	100	120	100	120	100	120	160	100	140	180	140	160	180	160	220			
Nominelle Verankerungstiefe h_{nom} [mm]	37	47	67	39	49	79	50	60	90	64	79	114	77	92	132	90	115	130
Wirksame Verankerungstiefe h_{ef} [mm]	30	40	60	30	40	70	40	50	80	50	65	100	65	80	120	75	100	115
Bohrlochtiefe (HD, HDB) $h_1 \geq$ [mm]	42	52	72	44	54	84	55	65	95	72	87	122	85	100	140	98	123	138
Bohrlochtiefe (DD) $h_1 \geq$ [mm]	-	-	-	-	-	-	58	68	98	72	87	122	85	100	140	98	123	138
Standard Anzugsdrehmoment																		
Anzugsdrehmoment T_{inst} [Nm]	5	15 ¹⁾²⁾	25 ¹⁾²⁾	50 ¹⁾²⁾	80 ¹⁾²⁾	200												
Minimaler Achsabstand s_{min} [mm]	35	35	50	70	90	195	175											
Minimaler Randabstand c_{min} [mm]	35	40	35	50	40	70	65	55	80	75	70	130	120					
Maximales Anzugsdrehmoment																		
Maximales Anzugsdrehmoment T_{max} [Nm]	5	20	35	80	150	250												
Minimaler Achsabstand s_{min} [mm]	35	35	40	50	80	120												
Minimaler Randabstand c_{min} [mm]	35	100	150	190	200	225												

1) Anziehen des Metallspreizankers mit Schlagschrauber in Kombination mit Setzwerkzeug unter Beachtung der erforderlichen Setzdauer alternativ möglich (siehe Anhang B2).

2) Anziehen des Metallspreizankers mit Schlagschrauber in Kombination mit Anzugsmodul alternativ möglich (siehe Anhang B2).

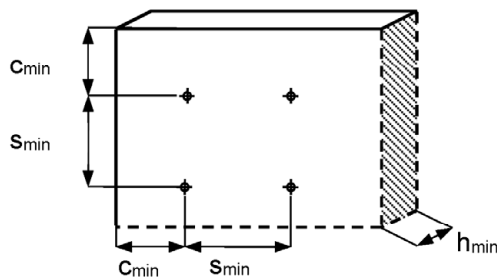

Hilti Metallspreizanker HSA

Verwendungszweck
Installationsparameter

Anhang B4

Bild B1: Konstante Ankerlänge für verschiedene Anbauteildicken t_{fix} sowie zugehörige Setzposition

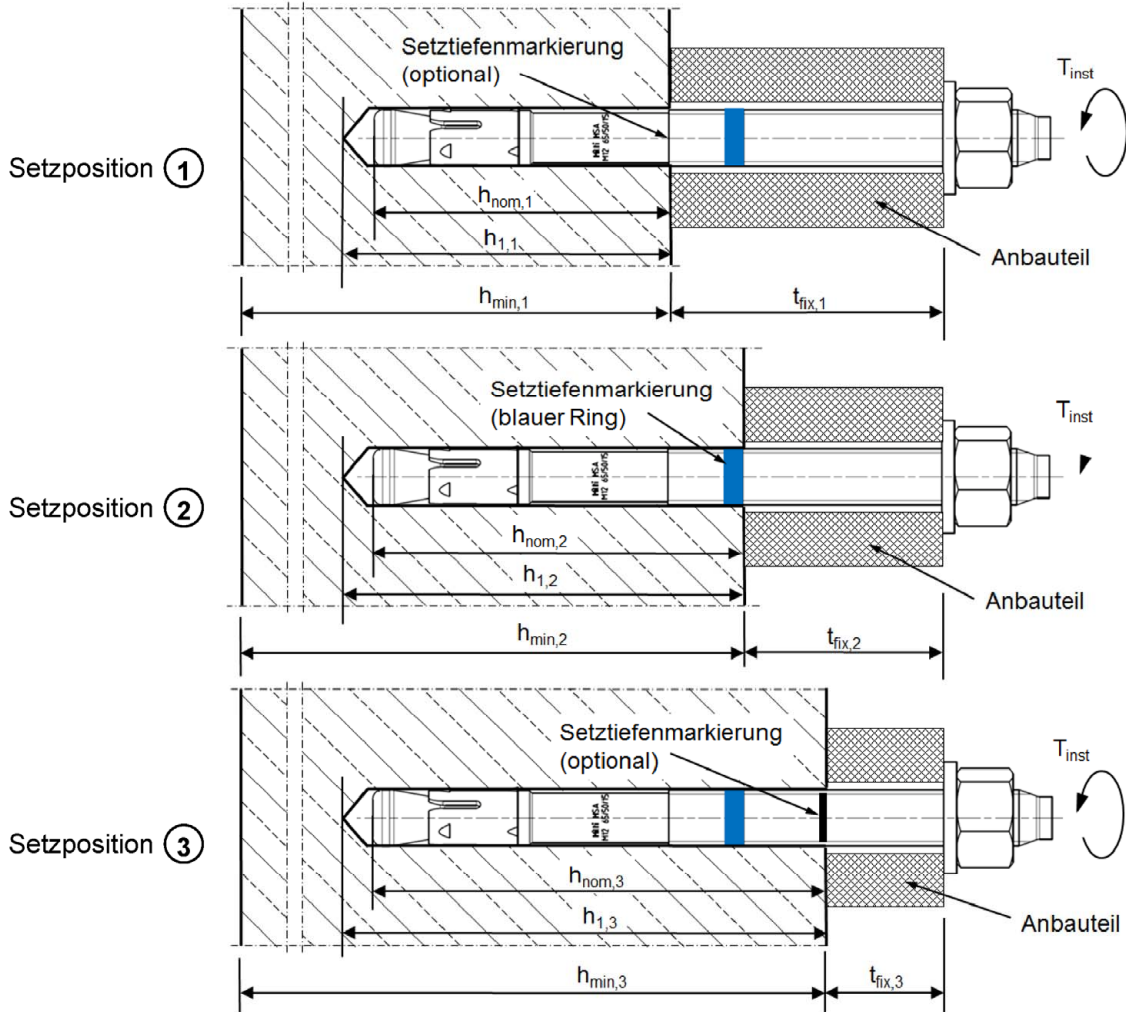

Hilti Metallspreizanker HSA

Verwendungszweck
Installationsparameter

Anhang B5

Bild B2: Unterschiedliche Ankerlängen mit verschiedenen Setzpositionen und der entsprechenden Anbauteildicke t_{fix}



Tabelle B7: Kontrolle der Setzposition

Setzposition	Vorsteckmontage	Durchsteckmontage
①	mit Buchstabencode "a" bis "z" (siehe Tabelle A2): $h_{nom,1}$ ist erreicht, wenn der glatte Nichtgewindebereich vollständig unterhalb der Betonoberfläche liegt. mit Buchstabencode "aa" bis "ag" (siehe Tabelle A2) und ohne Buchstabencode: $h_{nom,1}$ ist vom Monteur einzumessen und zu markieren.	$h_{nom,1}$, $h_{nom,2}$ bzw. $h_{nom,3}$ ist erreicht, wenn die vorhandenen Anbauteildicke t_{fix} und die maximalen Anbauteildicke $t_{fix,1}/t_{fix,2}/t_{fix,3}$ des Ankers übereinstimmen. Wenn die vorhandenen Anbauteildicke t_{fix} kleiner als die maximale Anbauteildicke $t_{fix,1}/t_{fix,2}/t_{fix,3}$ des Ankers ist, dann:
②	$h_{nom,2}$ ist erreicht, wenn der blaue Ring vollständig unterhalb der Betonoberfläche liegt.	<ul style="list-style-type: none"> Anpassen der Position der Scheibe und der Sechskantmutter oder Erhöhen der Bohrlochtiefe h_1.
③	$h_{nom,3}$ ist vom Monteur einzumessen und zu markieren.	

Hilti Metallspreizanker HSA

Verwendungszweck
Installationsparameter

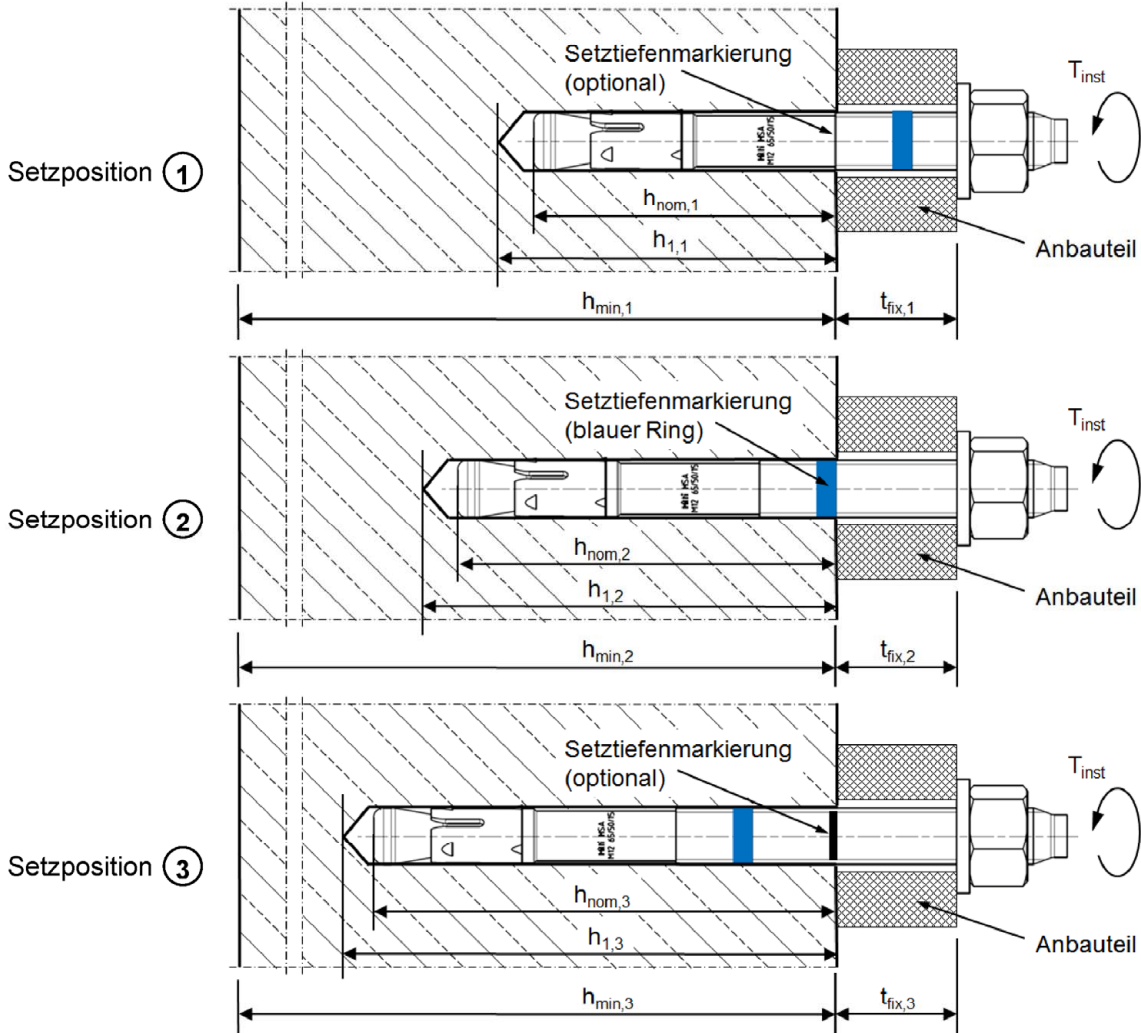
Anhang B6

Montageanweisung

Bohrlocherstellung und Reinigung (siehe Tabelle B1, Tabelle B2 und Tabelle B6)

a) Hammerbohren (HD) mit Handreinigung (MC)

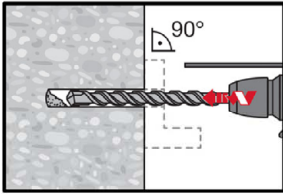

b) Hammerbohren mit Hilti Hohlbohrer (HDB) mit automatischer Reinigung (AC)

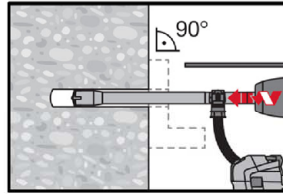

c) Diamantbohren (DD) mit Handreinigung (MC)

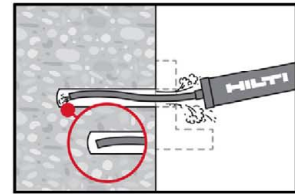
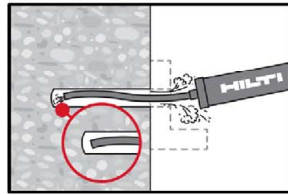
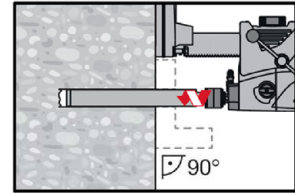

Setzen des Metallpreisankers (siehe Tabelle B3)

a) Setzen mit Hammer

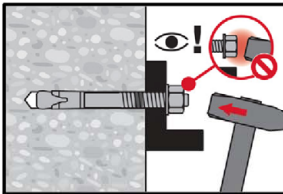

b) Setzen mit Maschine (Schlagschrauber mit Setzwerkzeug)

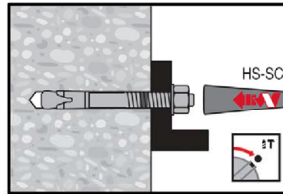

Kontrolle der Setzung (siehe Tabelle B7)

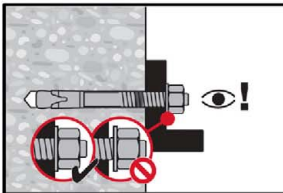

Anziehen des Metallpreisankers (siehe Tabelle B4 und Tabelle B5)

a) Drehmomentschlüssel

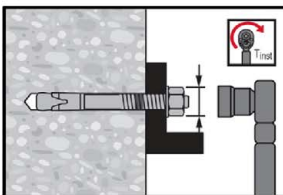

b) Schlagschrauber mit Setzwerkzeug

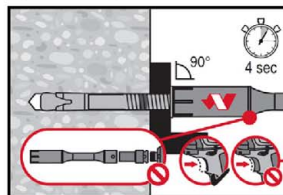

c) Schlagschrauber mit Modul

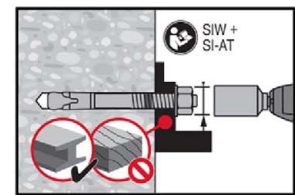

Kontrolle der Installation

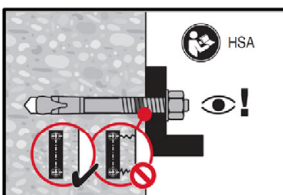

Hilti Metallpreisanker HSA

Verwendungszweck
Montageanweisung

Anhang B7

Tabelle C1: Charakteristischer Widerstand unter Zugbeanspruchung im ungerissenen Beton

Größe		M6			M8			M10			M12			M16			M20		
Setzposition		①	②	③	①	②	③	①	②	③	①	②	③	①	②	③	①	②	③
Wirksame Verankerungstiefe	h_{ef} [mm]	30 ¹⁾	40	60	30 ¹⁾	40	70	40	50	80	50	65	100	65	80	120	75	100	115
Stahlversagen																			
Teilsicherheitsbeiwert	$\gamma_{Ms}^{2)}$ [-]	1,4																	
HSA, HSA-BW																			
Charakteristischer Widerstand	$N_{Rk,s}$ [kN]	9,0			16,5			28,0			41,4			82,6			124		
HSA-F																			
Charakteristischer Widerstand	$N_{Rk,s}$ [kN]	9,5			15,9			27,0			40,4			80,1			3)		
HSA-R2, HSA-R																			
Charakteristischer Widerstand	$N_{Rk,s}$ [kN]	12,2			18,3			35,6			44,6			90,5			97,6		
Herausziehen																			
Montagesicherheitsbeiwert	γ_{inst} [-]	1,0																	
Charakteristischer Widerstand	$N_{Rk,p}$ [kN]	6	7,5	9	8,1	12,4	16	12,4	17,4	25	17,4	25,8	35	25,8	35,2	50	32	49,2	60,7
Erhöhungsfaktor ψ_c für $N_{Rk,p}$	C20/25 [-]	1,00																	
	C30/37 [-]	1,22																	
	C40/50 [-]	1,41																	
	C50/60 [-]	1,55																	
Betonausbruch und Spalten																			
Montagesicherheitsbeiwert	γ_{inst} [-]	1,0																	
Faktor für ungerissenen Beton	$k_{ucr,N}$ [-]	11,0																	
Faktor für gerissenen Beton	$k_{cr,N}$ [-]	3)																	
Achsabstand	$S_{cr,N}$ [mm]	$3 \cdot h_{ef}$																	
	$S_{cr,sp}$ [mm]	100	120	130	130	180	200	190	210	290	200	250	310	230	280	380	260	370	400
Randabstand	$C_{cr,N}$ [mm]	$1,5 \cdot h_{ef}$																	
	$C_{cr,sp}$ [mm]	50	60	65	65	90	100	95	105	145	100	125	155	115	140	190	130	185	200
Charakteristischer Widerstand	$N^0_{Rk,sp}$ [kN]	6	7,5	9	8,1	12,4	16	12,4	17,4	25	17,4	25,8	35	25,8	35,2	50	32	49,2	60,7

1) Die Verwendung ist auf statisch unbestimmte Bauteile unter den Bedingungen trockener Innenräume beschränkt.
 2) Sofern andere nationale Regelungen fehlen.
 3) Keine Leistung bewertet.

Hilti Metallpreisanker HSA

Leistung
Charakteristische Widerstand unter Zugbeanspruchung im ungerissenen Beton

Anhang C1

Tabelle C2: Charakteristischer Widerstand unter Querbeanspruchung im ungerissenen Beton

Größe	M6			M8			M10			M12			M16			M20		
	①	②	③	①	②	③	①	②	③	①	②	③	①	②	③	①	②	③
Setzposition																		
Wirksame Verankerungstiefe h_{ef} [mm]	30 ¹⁾	40	60	30 ¹⁾	40	70	40	50	80	50	65	100	65	80	120	75	100	115
Stahlversagen																		
Stahlversagen ohne Hebelarm																		
Teilsicherheitsbeiwert $\gamma_{Ms}^{2)}$ [-]	1,25																	
Duktilitätsfaktor k_7 [-]	1,0																	
HSA, HSA-BW																		
Charakteristischer Widerstand $V_{RK,s}^0$ [kN]	6,5			10,6			18,9			29,5			51,0			85,8		
HSA-F																		
Charakteristischer Widerstand $V_{RK,s}^0$ [kN]	6,5			10,6			18,9			29,5			51,0			3)		
HSA-R2, HSA-R																		
Charakteristischer Widerstand $V_{RK,s}^0$ [kN]	7,2			12,3			22,6			29,3			56,5			91,9		
Stahlversagen mit Hebelarm																		
Teilsicherheitsbeiwert $\gamma_{Ms}^{2)}$ [-]	1,25																	
Duktilitätsfaktor k_7 [-]	1,0																	
HSA, HSA-BW																		
Charakteristischer Widerstand $M_{RK,s}^0$ [Nm]	9,9			21,7			48,6			91,7			216			454		
HSA-F																		
Charakteristischer Widerstand $M_{RK,s}^0$ [Nm]	9,9			21,7			48,6			91,7			216			3)		
HSA-R2, HSA-R																		
Charakteristischer Widerstand $M_{RK,s}^0$ [Nm]	9,9			21,0			48,6			76,0			200			406		
Betonausbruch auf der lastabgewandten Seite																		
Montagesicherheitsbeiwert γ_{inst} [-]	1,0																	
Pryout-Faktor k_8 [-]	1	2		1	1,5	2	2,4			2			2,9			2		3,5
Betonkantenbruch																		
Montagesicherheitsbeiwert γ_{inst} [-]	1,0																	
Wirksame Ankerlänge l_r [mm]	30	40	60	30	40	70	40	50	80	50	65	100	65	80	120	75	100	115
Wirksamer äußerer Ankerdurchmesser d_{nom} [mm]	6			8			10			12			16			20		

¹⁾ Die Verwendung ist auf statisch unbestimmte Bauteile unter den Bedingungen trockener Innenräume beschränkt.

²⁾ Sofern andere nationale Regelungen fehlen.

³⁾ Keine Leistung bewertet.

Hilti Metallpreisanker HSA

Leistung

Charakteristische Widerstand unter Querbeanspruchung im ungerissenen Beton

Anhang C2

Tabelle C3: Verschiebung unter Zug- und Querbeanspruchung im ungerissenen Beton

Größe		M6			M8			M10			M12			M16			M20		
Setzposition		①	②	③	①	②	③	①	②	③	①	②	③	①	②	③	①	②	③
Wirksame Verankerungstiefe	h_{ef} [mm]	30	40	60	30	40	70	40	50	80	50	65	100	65	80	120	75	100	115
Verschiebung unter Zugbelastung																			
Zugkraft	N [kN]	2,9	3,6	4,3	4,0	6,1	7,6	6,1	8,5	11,9	8,5	12,6	16,7	12,6	17,2	23,8	16,6	25,1	30,8
Zugehörige Verschiebung	δ_{N0} [mm]	0,2	0,6	1,0	0,2	1,2	1,8	0,4	1,1	2,0	0,3	1,4	2,3	0,4	1,3	2,1	0,1	0,8	1,9
	$\delta_{N\infty}$ [mm]	0,6	1,0	1,4	0,6	1,6	2,2	0,8	1,5	2,4	0,7	1,8	2,7	0,8	1,7	2,5	0,5	1,2	2,3
Verschiebung unter Querbelastung																			
Querkraft	V [kN]	3,7			6,1			10,8			16,7			29,1			49,0		
Zugehörige Verschiebung	δ_{V0} [mm]	1,6			1,9			2,0			2,1			2,2			2,3		
	$\delta_{V\infty}$ [mm]	2,4			2,9			3,0			3,2			3,3			3,5		

Hilti Metallpreisanker HSA

Leistung
Verschiebung unter Zug- und Querbelastung im ungerissenen Beton

Anhang C3

Deutsches Institut für Bautechnik
Niemiecki Instytut Techniki Budowlanej

Jednostka aprobująca wyroby budowlane
i typy konstrukcji
Ośrodek Badawczy Techniki Budowlanej

Instytucja utworzona przez Rząd Federalny
i Rządy Krajów Związkowych

Upoważniona
zgodnie z Artykułem 29
Rozporządzenia
(Unii Europejskiej)
Nr 305/2011 oraz członek
EOTA (Europejskiej
Organizacji
ds. Ocen
Technicznych

Członek EOTA
www.eota.eu

Europejska Ocena Techniczna

ETA-11/0374 z 27 października 2023r.

Tłumaczenie angielskie przygotowane przez Niemiecki Instytut Techniki Budowlanej (DIBt) – Wersja oryginalna w języku niemieckim

Tłumaczenie z języka angielskiego na język polski na zlecenie Hilti (Poland) Sp. z o.o.

Część ogólna

Jednostka Oceny Technicznej wydająca
niniejszą Europejską Ocena Techniczną

Niemiecki Instytut Techniki Budowlanej

Nazwa handlowa wyrobu budowlanego

Metalowa kotwa rozporowa Hilti HSA

Rodzina produktów, do których należy wyrób
budowlany

Łącznik mechaniczny do stosowania w betonie
niezarysowanym

Producent

Hilti Spółka Akcyjna
9494 Schaan
KSIĘSTWO LIECHTENSTEIN

Zakład produkcyjny

Zakład produkcyjny Hilti

Niniejsza Europejska Ocena Techniczna
zawiera

19 stron, w tym 3 Załączniki, które stanowią
integralną część niniejszej oceny.

Niniejsza Europejska Ocena Techniczna
została wydana zgodnie
z Rozporządzeniem (Unii Europejskiej)
Nr 305/2011, na podstawie

EAD 330232-01-0601, wydanie z maja 2021r.

Niniejsza wersja zastępuje

ETA-11/0374 wydaną 3 listopada 2022r.

Niemiecki Instytut Techniki Budowlanej

Kolonnenstraße 30B | 10829 Berlin | NIEMCY | Telefon: +49 30 78730-0 | Faks: +49 30 78730-320 | E-mail: dibt@dibt.de | www.dibt.de

Niniejsza Europejska Ocena Techniczna została wydana przez Jednostkę Oceny Technicznej w jej języku oficjalnym. Tłumaczenie niniejszej Europejskiej Oceny Technicznej na inne języki musi w pełni odpowiadać oryginalnie wydanemu dokumentowi i powinno być wyraźnie oznaczone jako takowe.

Udostępnianie niniejszej Europejskiej Oceny Technicznej, włącznie z jej przesyłaniem za pomocą metod elektronicznych, jest dopuszczalne jedynie w całości. Kopiowanie części dokumentu może mieć miejsce, jednakże jedynie za pisemną zgodą wydającej go Jednostki Oceny Technicznej. Każde częściowe kopiowanie musi być wyraźnie oznaczone jako takowe.

Niniejsza Europejska Ocena Techniczna może zostać uchylona przez wydającą ją Jednostkę Oceny Technicznej, w szczególności na podstawie informacji Komisji zgodnie z treścią Artykułu 25 Paragraf 3 Rozporządzenia (Unii Europejskiej) Nr 305/2011.

Część szczegółowa dokumentu

1. Opis techniczny produktu

Metalowa kotwa rozporowa Hilti HSA jest łącznikiem rozporowym z rozporom kontrolowanym momentem dokręcającym, który jest umieszczany w wywierconym otworze i kotwiony poprzez zastosowanie rozporu, którego siła kontrolowana jest momentem dokręcającym.

Opis produktu został przedstawiony w Załączniku A.

2. Wyszczególnienie zamierzonego stosowania wyrobu zgodnie ze stosownym Europejskim Dokumentem Oceny

Właściwości użytkowe podane w Rozdziale 3 obowiązują wyłącznie wtedy, gdy kotwa jest stosowana zgodnie ze specyfikacjami i warunkami podanymi w Załączniku B.

Sprawdzenia i metody oceny, na których opiera się niniejsza Europejska Ocena Techniczna uwzględniają założenie, że okres użytkowania kotwy będzie wynosił przynajmniej 50 lat. Wskazania dotyczące okresu użytkowania nie mogą być interpretowane jako gwarancja udzielona przez producenta, a jedynie jako przesłanki mające pomóc w wyborze odpowiedniego produktu spełniającego oczekiwania z punktu widzenia ekonomicznie uzasadnionej trwałości wykonanych prac montażowych.

3. Właściwości użytkowe produktu oraz informacje na temat metod użytych do ich oceny

3.1 Wytrzymałość mechaniczna i stateczność (Podstawowe wymaganie 1)

Podstawowa charakterystyka	Właściwości
Nośność charakterystyczna na obciążenia rozciągające (obciążenia statyczne i quasi-statyczne) Metoda A	Patrz→ Załącznik B3 oraz C1
Nośność charakterystyczna na obciążenia ścinające (obciążenia statyczne i quasi-statyczne)	Patrz→ Załącznik C2
Przemieszczenia	Patrz→ Załącznik C3
Nośność charakterystyczna oraz przemieszczenia dla kategorii właściwości sejsmicznych C1 oraz C2	Właściwości nie zostały poddane ocenie

3.2 Bezpieczeństwo pożarowe (Podstawowe wymaganie 2)

Podstawowa charakterystyka	Właściwości
Reakcja na działanie ognia	Klasa A1
Odporność ogniowa	Właściwości nie zostały poddane ocenie

3.3 Aspekty wytrzymałości powiązane z Podstawowymi Wymaganiami

Podstawowa charakterystyka	Właściwości
Wytrzymałość	Patrz→ Załącznik B1

4 Zastosowany system oceny i weryfikacji stałości właściwości użytkowych (AVCP) oraz informacje nt. podstawy prawnej

Zgodnie z Europejskim Dokumentem Oceny EAD 330232-00-0601 zastosowanie ma europejski akt prawny: [96/582/EC].

Zastosowanie ma system: 1.

5 Szczegóły techniczne konieczne do wdrożenia systemu oceny i weryfikacji stałości właściwości użytkowych (AVCP) uwzględnione w odpowiednim Europejskim Dokumentcie Oceny

Szczegóły techniczne konieczne do wdrożenia systemu oceny i weryfikacji stałości właściwości użytkowych (AVCP) są zawarte w planie kontroli przechowywanym w Niemieckim Instytucie Techniki Budowlanej.

Dokument wydany w Berlinie 27 października 2023r. przez Niemiecki Instytut Techniki Budowlanej

Dr Inż. Beatrix Wittstock
Kierownik Działu

uwierzytelnione przez:
Ziegler

Warunki montażu

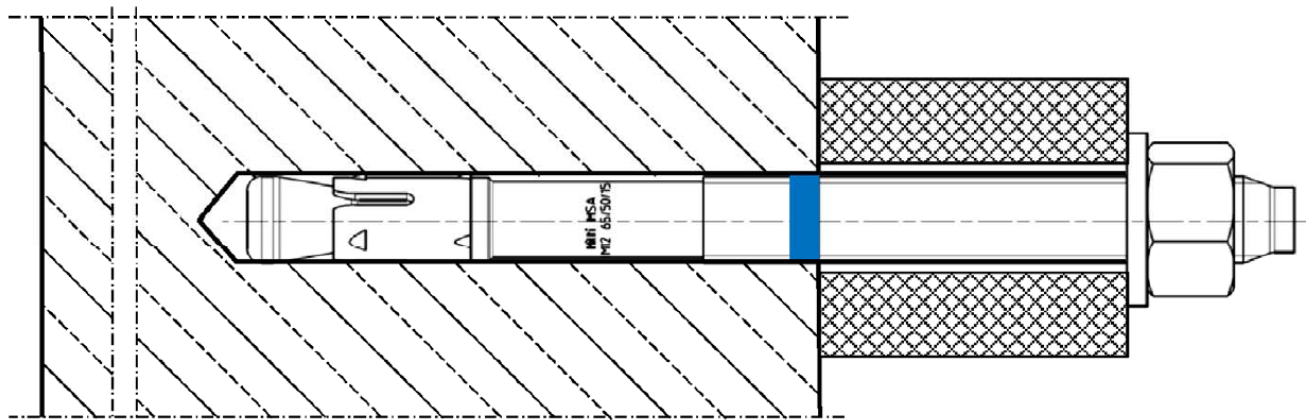

Metalowa kotwa rozporowa Hilti HSA

Opis produktu
Warunki montażu

Załącznik A1

Opis produktu: metalowa kotwa rozporowa Hilti HSA, HSA-BW, HSA-F, HSA-R2 oraz HSA-R



Tabela A1: Kod materiału do identyfikacji różnych materiałów

	HSA, HSA-BW, HSA-F	HSA-R2	HSA-R
Kod materiału	 Oznaczenie literowe bez znaku	 Oznaczenie literowe z dwoma znakami	 Oznaczenie literowe z trzema znakami

Metalowa kotwa rozporowa Hilti HSA

Opis produktu
Oznaczenie produktu oraz kod materiału do identyfikacji metalowej kotwy rozporowej

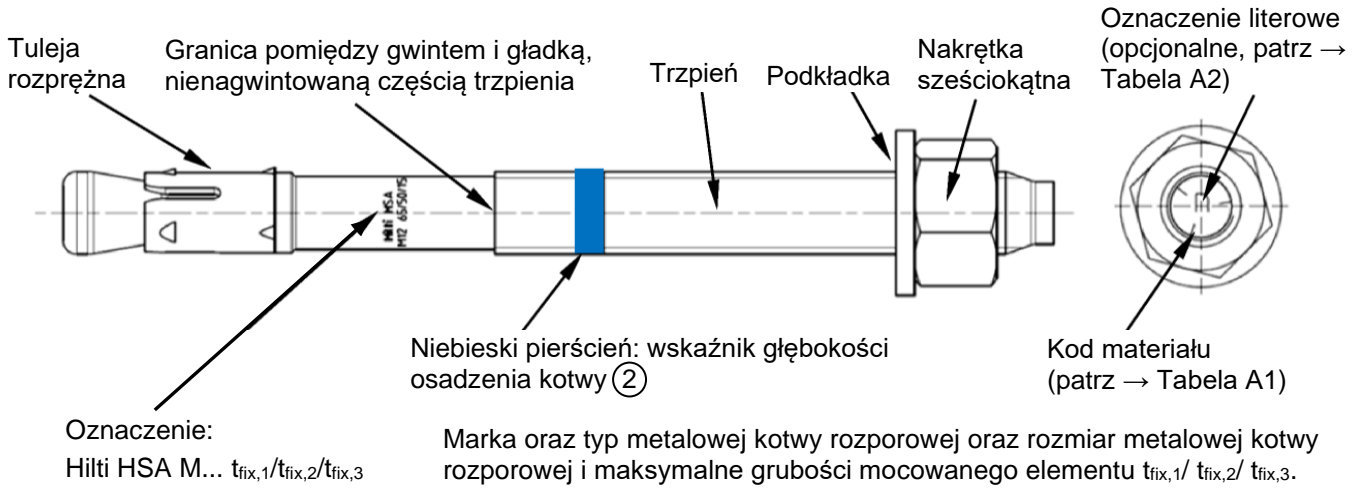
Załącznik A2

Tabela A2: Oznaczenie literowe do identyfikacji maksymalnej grubości elementu mocowanego (opcjonalne)¹⁾

Rożmiar	M6	M8	M10	M12	M16	M20
	$t_{fix,1}/t_{fix,2}/t_{fix,3}$	$t_{fix,1}/t_{fix,2}/t_{fix,3}$	$t_{fix,1}/t_{fix,2}/t_{fix,3}$	$t_{fix,1}/t_{fix,2}/t_{fix,3}$	$t_{fix,1}/t_{fix,2}/t_{fix,3}$	$t_{fix,1}/t_{fix,2}/t_{fix,3}$
	[mm]/[mm]/[mm/]	[mm]/[mm]/[mm/]	[mm]/[mm]/[mm/]	[mm]/[mm]/[mm/]	[mm]/[mm]/[mm/]	[mm]/[mm]/[mm/]
<u>z</u>	5/-	5/-	5/-	5/-	5/-	5/-
<u>y</u>	10/-	10/-	10/-	10/-	10/-	10/-
<u>x</u>	15/5-	15/5-	15/5-	15/-	15/-	15/-
<u>w</u>	20/10-	20/10-	20/10-	20/5-	20/5-	20/-
<u>v</u>	25/15-	25/15-	25/15	25/10-	25/10-	25/-
<u>u</u>	30/20-	30/20-	30/20-	30/15-	30/15-	30/5-
<u>t</u>	35/25/5	35/25-	35/25-	35/20-	35/20-	35/10-
<u>s</u>	40/30/10	40/30-	40/30-	40/25-	40/25-	40/15-
<u>r</u>	45/35/15	45/35/5	45/35/5	45/30-	45/30-	45/20/5
<u>q</u>	50/40/20	50/40/10	50/40/10	50/35-	50/35-	50/25/10
<u>p</u>	55/45/25	55/45/15	55/45/15	55/40/5	55/40-	55/30/15
<u>o</u>	60/50/30	60/50/20	60/50/20	60/45/10	60/45/5	60/35/20
<u>n</u>	65/55/35	65/55/25	65/55/25	65/50/15	65/50/10	65/40/25
<u>m</u>	70/60/40	70/60/30	70/60/30	70/55/20	70/55/15	70/45/30
<u>l</u>	75/65/45	75/65/35	75/65/35	75/60/25	75/60/20	75/50/35
<u>k</u>	80/70/50	80/70/40	80/70/40	80/65/30	80/65/25	80/55/40
<u>j</u>	85/75/55	85/75/45	85/75/45	85/70/35	85/70/30	85/60/45
<u>i</u>	90/80/60	90/80/50	90/80/50	90/75/40	90/75/35	90/65/50
<u>h</u>	95/85/65	95/85/55	95/85/55	95/80/45	95/80/40	95/70/55
<u>g</u>	100/90/70	100/90/60	100/90/60	100/85/50	100/85/45	100/75/60
<u>f</u>	105/95/75	105/95/65	105/95/65	105/90/55	105/90/50	105/80/65
<u>e</u>	110/100/80	110/100/70	110/100/70	110/95/60	110/95/55	110/85/70
<u>d</u>	115/105/85	115/105/75	115/105/75	115/100/65	115/100/60	115/90/75
<u>c</u>	120/110/90	120/110/80	120/110/80	125/110/75	120/105/65	120/95/80
<u>b</u>	125/115/95	125/115/85	125/115/85	135/120/85	125/110/70	125/100/85
<u>a</u>	130/120/100	130/120/90	130/120/90	145/130/95	135/120/80	130/105/90
aa	-	-	-	155/140/105	145/130/90	-
ab	-	-	-	165/150/115	155/140/100	-
ac	-	-	-	175/160/125	165/150/110	-
ad	-	-	-	180/165/130	190/175/135	-
ae	-	-	-	230/215/180	240/225/185	-
af	-	-	-	280/265/230	290/275/235	-
ag	-	-	-	330/315/280	340/325/285	-

¹⁾ Dla standardowych kotew długości podano czcionką pogrubioną. W przypadku wyboru innych długości kotew należy sprawdzić dostępność artykułów.

Metalowa kotwa rozporowa Hilti HSA

Opis produktu

Oznaczenia literowe do identyfikacji metalowej kotwy rozporowej

Załącznik A3

Tabela A3: Materiały

Opis elementu	Materiał
HSA, HSA-BW	
Tuleja rozprężna	M6: Stal nierdzewna A2 zgodna z normą EN 10088-1:2014 M8 – M20: Stal węglowa, ocynkowana galwanicznie
Trzpień kotwy	Stal węglowa, ocynkowana galwanicznie, wydłużenie przy zerwaniu ($l_0 = 5d$) > 8%
Podkładka	Stal węglowa, ocynkowana galwanicznie
Nakrętka sześciokątna	Stal węglowa, ocynkowana galwanicznie
HSA-F	
Tuleja rozprężna	Stal nierdzewna A2 zgodna z normą EN 10088-1:2014
Trzpień kotwy	Stal ocynkowana ogniowo, wydłużenie przy zerwaniu ($l_0 = 5d$) > 8%
Podkładka	Stal ocynkowana ogniowo
Nakrętka sześciokątna	Stal ocynkowana ogniowo
HSA-R2 (stal nierdzewna) Klasa II odporności na korozję zgodna z EN 1993-1-4:2006+A1:2015	
Tuleja rozprężna	Stal nierdzewna A2 zgodna z normą EN 10088-1:2014
Trzpień kotwy	Stal nierdzewna zgodna z normą EN 10088-1:2014, powlekana, wydłużenie przy zerwaniu ($l_0 = 5d$) > 8%
Podkładka	Stal nierdzewna A2
Nakrętka sześciokątna	Stal nierdzewna A2, powlekana
HSA-R (stal nierdzewna) Klasa III odporności na korozję zgodna z EN 1993-1-4:2006+A1:2015	
Tuleja rozprężna	Stal nierdzewna A2 zgodna z normą EN 10088-1:2014
Trzpień kotwy	Stal nierdzewna zgodna z normą EN 10088-1:2014, powlekana, wydłużenie przy zerwaniu ($l_0 = 5d$) > 8% ciągliwa
Podkładka	Stal nierdzewna A4
Nakrętka sześciokątna	Stal nierdzewna A4, powlekana

Metalowa kotwa rozporowa Hilti HSA

Opis produktu
Materiały

Załącznik A4

Tabela A4: Wymiary metalowych kotew rozporowych Hilti HSA, HSA-BW, HSA-F, HSA-R2 oraz HSA-R

	M6	M8	M10	M12	M16	M20
Minimalna wewnętrzna średnica podkładki d_1 [mm]	6,4	8,4	10,5	13	17	21
Minimalna zewnętrzna średnica podkładki d_w [mm]	12	16	20	24	30	37
Minimalna grubość podkładki h [mm]	1,6	1,6	2	2,5	3	3

Rysunek A1: Metalowa kotwa rozporowa Hilti HSA, HSA-F, HSA-R2, HSA-R

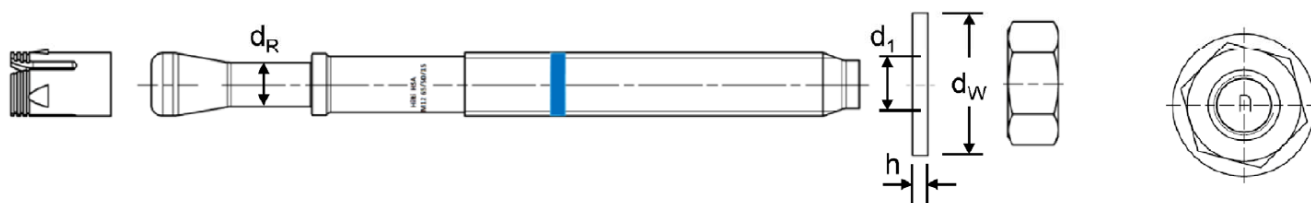

Rysunek A2: Metalowa kotwa rozporowa Hilti HSA-BW

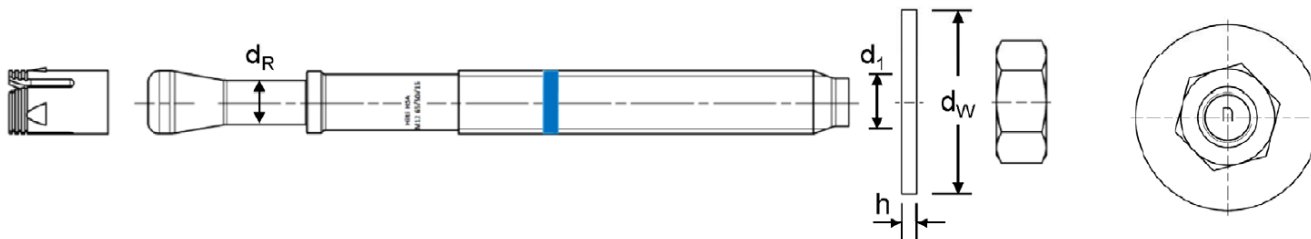

Metalowa kotwa rozporowa Hilti HSA

Opis produktu
Wymiary

Załącznik A5

Szczegóły techniczne zamierzonego stosowania

Zakotwienia poddawane:

- Obciążeniom statycznym i quasi-statycznym.

Materiały podłoża:

- Zagęszczony, zbrojony lub niezbrojony beton o standardowym ciężarze bez włókien zgodny z normą EN 206:2013+A1:2016.
- Klasy wytrzymałości betonu od C20/25 do C50/60 zgodnie z normą EN 206:2013+A1:2016.
- Beton niezarysowany.

Warunki stosowania (warunki środowiskowe):

- Konstrukcje poddane oddziaływaniu warunków suchych wewnątrz budowli (wszystkie materiały).
- Dla wszelkich pozostałych warunków zgodnych z normą EN 1993-1-4:2006+A1:2015, odpowiadających klasom odporności na korozję wg. Załącznika A, Tabela A3 (stal nierdzewna).

Projektowanie:

- Zakotwienia muszą być zaprojektowane pod nadzorem inżyniera doświadczonego w dziedzinie zakotwień i robót betonowych.
- Należy wykonać możliwe do weryfikacji obliczenia oraz opracować rysunki, biorąc pod uwagę obciążenia, które mają być przeniesione przez kotwy. Położenie metalowych kotew rozporowych musi być określone na rysunkach projektowych (np. poprzez podanie położenia metalowej kotwy rozporowej względem zbrojenia lub względem podpór, itd.)
- Zakotwienia poddawane obciążeniom statycznym lub quasi-statycznym muszą być zaprojektowane zgodnie z:
Normą EN 1992:2018 oraz z Raportem Technicznym EOTA TR 055:2018r.

Montaż:

- Montaż kotew może być przeprowadzony wyłącznie przez odpowiednio wykwalifikowany personel oraz pod odpowiednim nadzorem osoby odpowiedzialnej za kwestie techniczne na budowie.
- Każda kotwa może być osadzona tylko raz.

Metalowa kotwa rozporowa Hilti HSA

Zamierzone stosowanie
Specyfikacje

Załącznik B1

Tabela B1: Technika wiercenia otworów



Rozmiar kotwy		M6	M8	M10	M12	M16	M20
Wiercenie udarowe (HD)					✓		
Wiercenie udarowe przy użyciu systemu (HDB) wiertła rurowego Hilti TE-CD/YD		-	-	-		✓	
Wiercenie diamentowe rdzeniowe (DD) przy użyciu wiertnicy DD 30-W z wiertłami rdzeniowymi C+ ... SPX-T (abrazyjnymi)		-	-			✓	

Tabela B2: Czyszczenie wywierconych otworów



Ręczne czyszczenie otworów (MC): Ręczna pompka Hilti do wydmuchiwania zwiercin.	
Automatyczne czyszczenie otworów (AC): Czyszczenie ma miejsce podczas wiercenia otworu przy zastosowaniu systemu wiercenia Hilti TE-CD i TE-YD wyposażonego w odkurzacz przemysłowy.	

Tabela B3: Metody osadzania kotew



Rozmiar kotwy	M6	M8	M10	M12	M16	M20
Osadzanie udarowe				✓		
Osadzanie maszynowe, mechaniczne (wkrętarka udarowa z narzędziem do osadzania kotew)	-			✓		

Metalowa kotwa rozporowa Hilti HSA

Zamierzone stosowanie
Metody montażu

Załącznik B2

Tabela B4: Metody przykładania momentów dokręcających

Rozmiar kotwy		M6	M8	M10	M12	M16	M20
Klucz dynamometryczny 		✓					
Narzędzie do osadzania kotew S-TB HSA ... z wkrętarką udarową Hilti SIW ... ¹⁾ 		-	✓				-
		-	14-A / 22-A / 6AT-A22			22T-A	-
Prędkość osadzania	HSA, HSA-BW, HSA-F	-	I	I	III	- ²⁾	
	HSA-R2, HSA-R	-	III				-
Czas osadzania	t _{set} [sekundy]	-	4				-
Maszynowe dokręcanie kotwy przy użyciu wkrętarki udarowej Hilti SIW z modulem dynamometrycznym SI-AT 							
<ul style="list-style-type: none"> • SIW 4AT-22 z SI-AT-22³⁾ HSA, HSA-BW, HSA-R2, • SIW 6AT-22 z SI-AT-22³⁾ HSA-R 		-	✓	✓	✓	✓	-
		-	-	✓	✓	✓	✓

¹⁾ Patrz → Tabela B5 z informacjami na temat stanu naładowania baterii w zależności od temperatury otoczenia.

²⁾ Wkrętarka udarowa pracuje z ustaloną prędkością.

³⁾ Możliwe jest zastosowanie równoważnej kombinacji narzędzi Hilti SIW + SI-AT kompatybilnych z tym typem kotwy.

Tabela B5: Stan naładowania baterii wkrętarki udarowej

Temperatura otoczenia		≤ +5 °C	od +5 do +10 °C	≥ +10 °C
Stan naładowania baterii	niski	-	-	-
	średni	-	-	✓
	wysoki	-	✓	✓

Metalowa kotwa rozporowa Hilti HSA

Zamierzone stosowanie
Metody montażu

Załącznik B3

Tabela B6: Parametry montażowe

Rozmiar kotwy	M6			M8			M10			M12			M16			M20																													
Nominalna średnica wiertła d_0 [mm]	6			8			10			12			16			20																													
Maksymalna średnica tnąca wiertła d_{cut} [mm]	6,40			8,45			10,45			12,5			16,5			20,55																													
Średnica otworu przelotowego w elemencie mocowanym d_f [mm]	7			9			12			14			18			22																													
Rozwartość klucza S_w [mm]	10			13			17			19			24			30																													
Pozycja osadzania	①	②	③	①	②	③	①	②	③	①	②	③	①	②	③	①	②	③																											
Minimalna grubość elementu betonowego h_{min} [mm]	100			120			100			120			100			120			160			100			140			180			140			160			180			160			220		
Nominalna głębokość zakotwienia h_{nom} [mm]	37	47	67	39	49	79	50	60	90	64	79	114	77	92	132	90	115	130																											
Czynna głębokość zakotwienia h_{ef} [mm]	30	40	60	30	40	70	40	50	80	50	65	100	65	80	120	75	100	115																											
Minimalna głębokość wierconego otworu (HD, HDB) h_1 [mm]	42	52	72	44	54	84	55	65	95	72	87	122	85	100	140	98	123	138																											
Minimalna głębokość wierconego otworu (DD) h_1 [mm]	-			-			58	68	98	72	87	122	85	100	140	98	123	138																											
Standardowy montażowy moment dokręcający																																													
Montażowy moment dokręcający T_{inst} [Nm]	5			15 ^{1) 2)}			25 ^{1) 2)}			50 ^{1) 2)}			80 ^{1) 2)}			200																													
Minimalny rozstaw S_{min} [mm]	35			35			50			70			90			195	175																												
Minimalna odległość od krawędzi C_{min} [mm]	35			40	35	50	40	70	65	55	80	75	70	130	120																														
Maksymalny montażowy moment dokręcający																																													
Maksymalny montażowy moment dokręcający T_{max} [Nm]	-			20			35			80			150			250																													
Minimalny rozstaw S_{min} [mm]	-			35			40			50			80			120																													
Minimalna odległość od krawędzi C_{min} [mm]	-			100			150			190			200			225																													

¹⁾ Alternatywnie ta metalowa kotwa rozporowa może być dokręcona przy użyciu wkrętarki udarowej w połączeniu z narzędziem do osadzania kotew w wymaganym czasie osadzania (patrz → Załącznik B2).

²⁾ Alternatywnie ta metalowa kotwa rozporowa może być dokręcona przy użyciu wkrętarki udarowej w połączeniu z modułem (patrz → Załącznik B2).

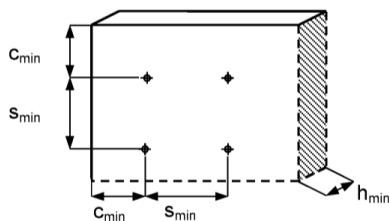

Metalowa kotwa rozporowa Hilti HSA

Zamierzone stosowanie
Parametry montażowe

Załącznik B4

Rysunek B1: Stała długość kotwy dla różnych grubości mocowanego elementu t_{fix} oraz odpowiednich pozycji osadzenia

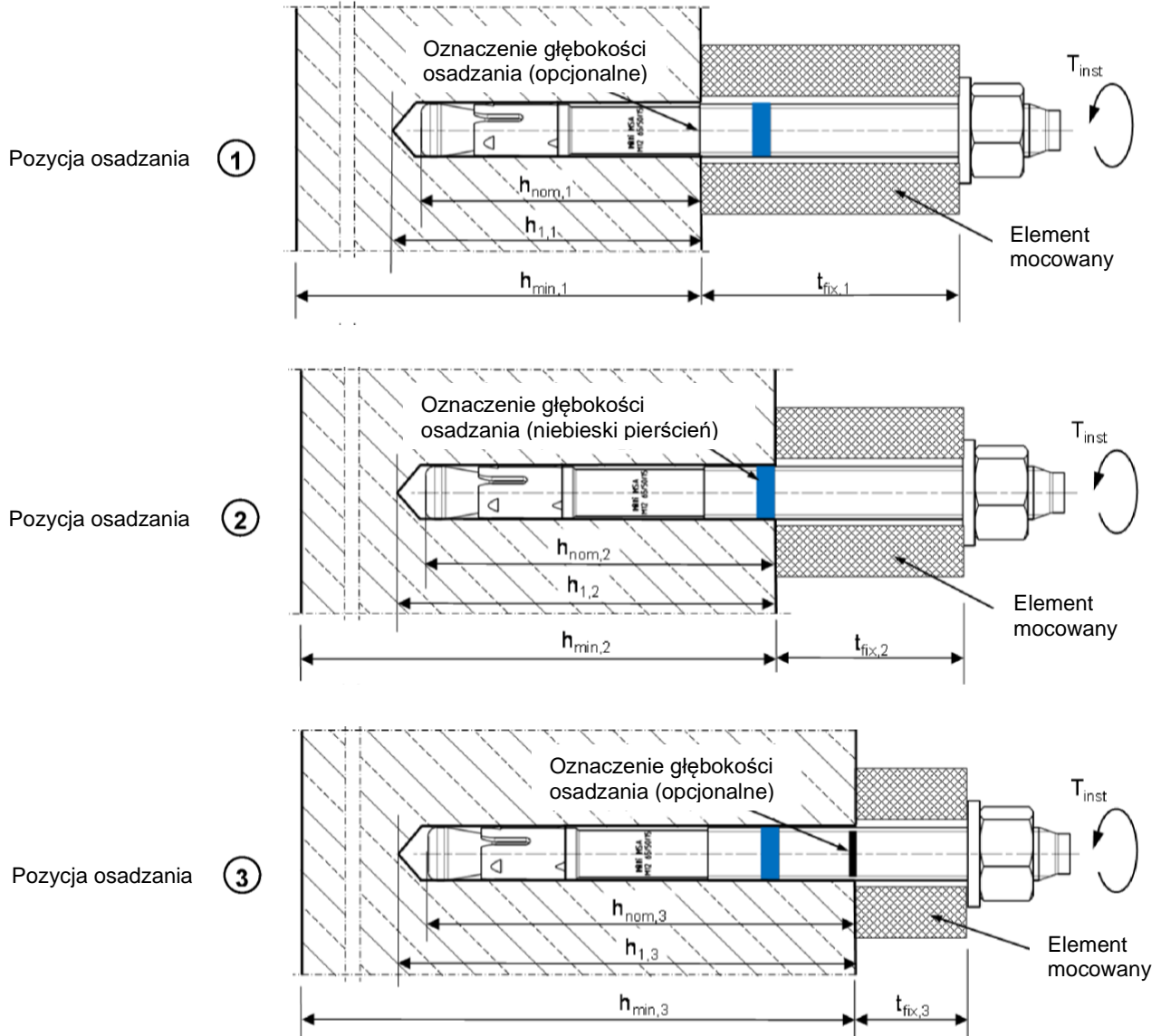

Metalowa kotwa rozporowa Hilti HSA

Zamierzone stosowanie
Parametry montażowe

Załącznik B5

Rysunek B2: Różne długości kotew dla różnych pozycji osadzania i odpowiednich grubości mocowanego elementu t_{fix}



Tabela B7: Kontrola pozycji osadzenia kotwy

Pozycja osadzenia	Metoda montażu nieprzelotowego	Metoda montażu przelotowego kotwy
①	z oznaczeniem literowym od „a” do „z” (patrz →Tabela A2): $h_{nom,1}$ jest osiągnięta, kiedy nienagwintowana część trzpienia znajduje się w całości pod powierzchnią betonu. z oznaczeniem literowym od „aa” do „ag” (patrz→Tabela A2) oraz bez oznaczenia literowego: $h_{nom,1}$ musi być zmierzone i oznaczone przez osobę wykonującą montaż.	$h_{nom,1}$, $h_{nom,2}$ lub $h_{nom,3}$ jest osiągnięta, kiedy aktualna grubość mocowanego elementu t_{fix} oraz maksymalna grubość mocowanego elementu $t_{fix,1}/t_{fix,2}/t_{fix,3}$ podana dla kotwy są identyczne. Jeśli aktualna grubość mocowanego elementu t_{fix} jest mniejsza, niż maksymalna grubość mocowanego elementu $t_{fix,1}/t_{fix,2}/t_{fix,3}$ podana dla kotwy, wówczas <ul style="list-style-type: none"> • konieczne jest dostosowanie pozycji podkładki i nakrętki sześciokątnej • głębokość wierconego otworu h_1 musi zostać zwiększona.
②	$h_{nom,2}$ jest osiągnięta, kiedy niebieski pierścień znajduje się w całości pod powierzchnią betonu.	
③	$h_{nom,3}$ musi być zmierzone i oznaczone przez osobę wykonującą montaż.	

Metalowa kotwa rozporowa Hilti HSA

Zamierzone stosowanie
Parametry montażowe

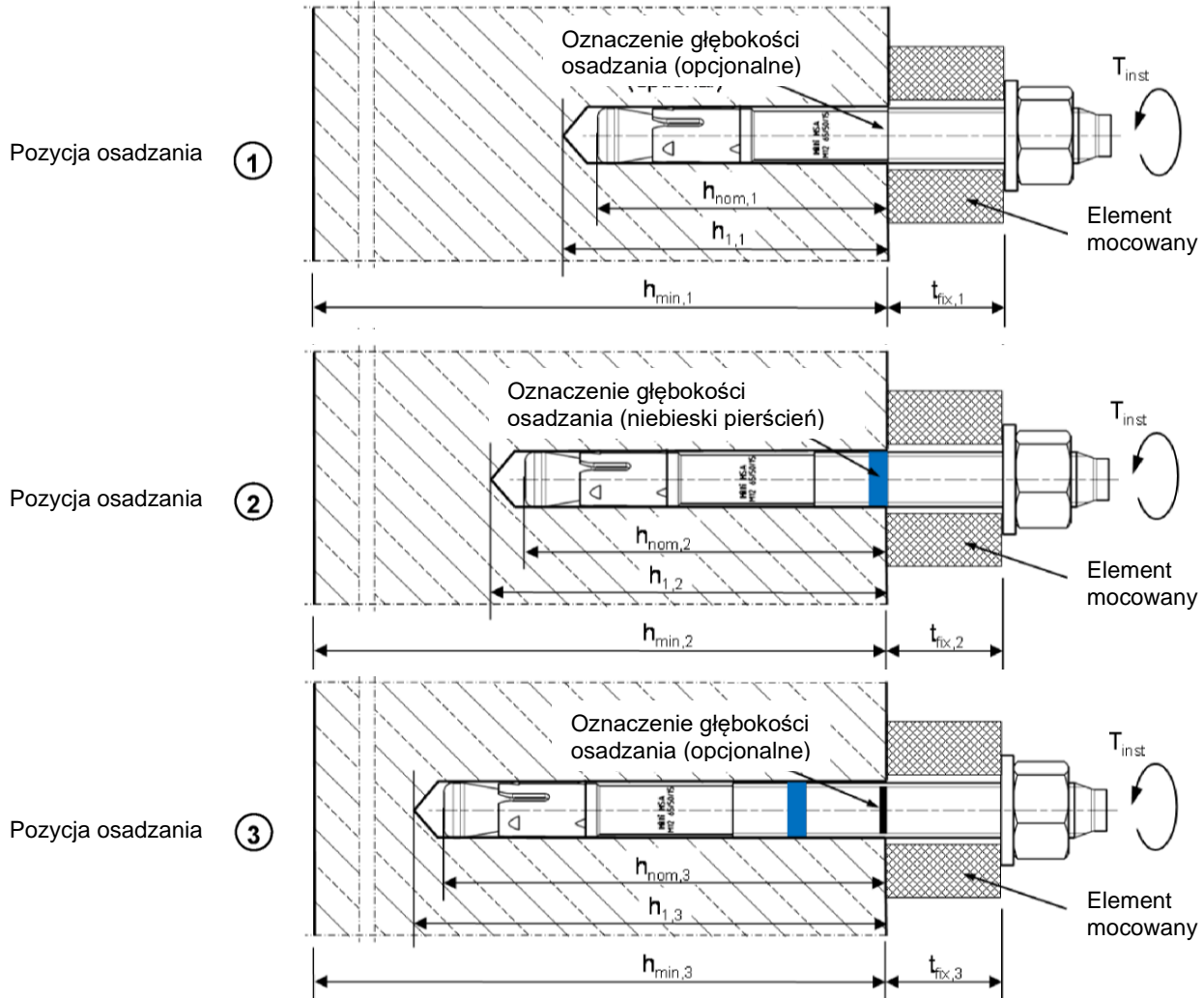
Załącznik B6

Instrukcja montażu kotew

Wiercenie i czyszczenie otworu (patrz→ Tabela B1, Tabela B2 oraz Tabela B6)

a) Wiercenie udarowe (HD) z czyszczeniem ręcznym (MC)

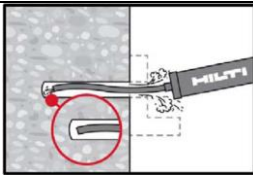
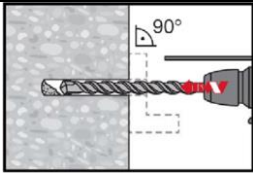

b) Wiercenie udarowe przy użyciu wiertel rurowych Hilti (HDB) z czyszczeniem automatycznym (AC)

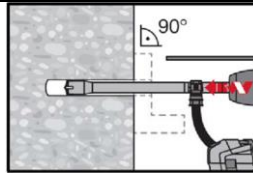

c) Wiercenie diamentowe (DD) z czyszczeniem ręcznym (MC)

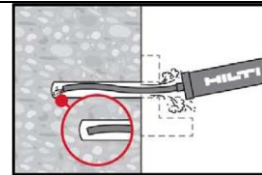
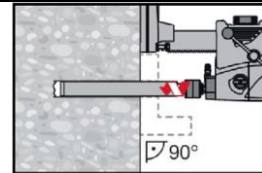

Osadzanie kotew (patrz→ Tabela B3)

a) Osadzanie udarowe

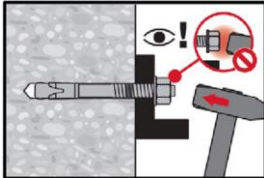

b) Osadzanie maszynowe (wkrętarka udarowa z narzędziem do osadzania)

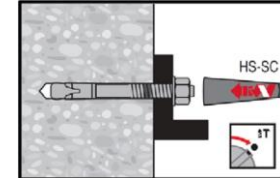

Kontrola osadzenia kotwy (patrz→ Tabela B7)

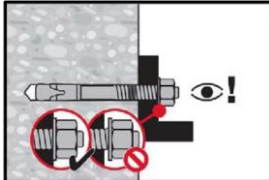

Dokręcanie kotew (patrz→ Tabela B4 oraz Tabela B5)

a) Klucz dynamometryczny

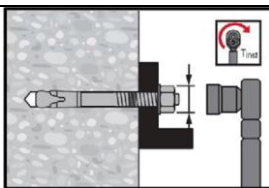

b) Wkrętarka udarowa z narzędziem do osadzania

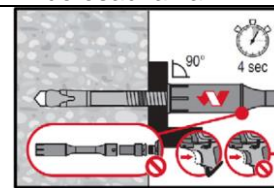

c) Wkrętarka udarowa z modulem

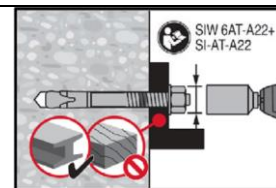

Kontrola prawidłowości montażu

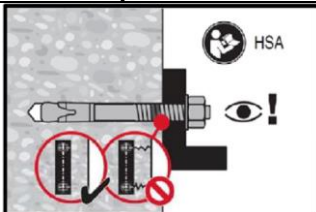

Metalowa kotwa rozporowa Hilti HSA

Zamierzone stosowanie
Instrukcje montażu kotew

Załącznik B7

Tabela C1: Nośność charakterystyczna pod wpływem obciążeń rozciągających w betonie niespękanym

Rozmiar kotwy	M6			M8			M10			M12			M16			M20		
Pozycja osadzania	1	2	3	1	2	3	1	2	3	1	2	3	1	2	3	1	2	3
Czynna głębokość zakotwienia h_{ef} [mm]	30 ¹⁾	40	60	30 ¹⁾	40	70	40	50	80	50	65	100	65	80	120	75	100	115
Zniszczenie stali																		
Częściowy współczynnik bezpieczeństwa $\gamma_{Ms}^{2)}$ [-]	1,4																	
HSA, HSA-BW																		
Nośność charakterystyczna $N_{Rk,s}$ [kN]	9,0			16,5			28,0			41,4			82,6			124		
HSA-F																		
Nośność charakterystyczna $N_{Rk,s}$ [kN]	9,5			15,9			27,0			40,4			80,1			3)		
HSA-R2, HSA-R																		
Nośność charakterystyczna $N_{Rk,s}$ [kN]	12,2			18,3			35,6			44,6			90,5			97,6		
Zniszczenie przez wyciągnięcie kotwy																		
Montażowy współczynnik bezpieczeństwa γ_{inst} [-]	1,0																	
Nośność charakterystyczna $N_{Rk,p}$ [kN]	6	7,5	9	8,1	12,4	16	12,4	17,4	25	17,4	25,8	35	25,8	35,2	50	32	49,2	60,7
Współczynnik zwiększający Ψ_c	C20/25 [-]	1,00																
	C30/37 [-]	1,22																
	C40/50 [-]	1,41																
	C50/60 [-]	1,55																
Zniszczenie przez wyrwanie stożka betonu i rozłupanie betonu																		
Montażowy współczynnik bezpieczeństwa γ_{inst} [-]	1,00																	
Współczynnik dla betonu niespękanego $k_{ucr,N}$ [-]	11,0																	
Współczynnik dla betonu spękanego $k_{cr,N}$ [-]	3)																	
Rozstaw kotew	$S_{cr,N}$ [mm]	$3 \cdot h_{ef}$																
	$S_{cr,sp}$ [mm]	100	120	130	130	180	200	190	210	290	200	250	310	230	280	380	260	370
Odległość od krawędzi podłoża	$C_{cr,N}$ [mm]	$1,5 \cdot h_{ef}$																
	$C_{cr,sp}$ [mm]	50	60	65	65	90	100	95	105	145	100	125	155	115	140	190	130	185
Nośność charakterystyczna $N_{Rk,sp}^0$ [kN]	6	7,5	9	8,1	12,4	16	12,4	17,4	25	17,4	25,8	35	25,8	35,2	50	32	49,2	60,7

- ¹⁾ Zastosowanie jest ograniczone do wykonywania zakotwień statycznie niewyznaczalnych elementów konstrukcji oraz do warunków suchych panujących wewnątrz budowli.
²⁾ W przypadku braku innych przepisów krajowych.
³⁾ Nie wykonano oceny.

Metalowa kotwa rozporowa Hilti HSA

Charakterystyka produktu

Nośność charakterystyczna pod wpływem obciążeń rozciągających w betonie niespękanym

Załącznik C1

Tabela C2: Nośność charakterystyczna pod wpływem obciążeń ścinających w betonie niespękanym

Rozmiar kotwy	M6			M8			M10			M12			M16			M20		
Pozycja osadzania	1	2	3	1	2	3	1	2	3	1	2	3	1	2	3	1	2	3
Czynna głębokość zakotwienia h_{ef} [mm]	30 ¹⁾	40	60	30 ¹⁾	40	70	40	50	80	50	65	100	65	80	120	75	100	115
Zniszczenie stali bez oddziaływania momentu zginającego																		
Częściowy współczynnik bezpieczeństwa $\gamma_{Ms}^{2)}$ [-]	1,25																	
Współczynnik ciągliwości k_7	1,0																	
HSA, HSA-BW																		
Nośność charakterystyczna $V_{Rk,s}^0$ [kN]	6,5			10,6			18,9			29,5			51,0			85,8		
HSA-F																		
Nośność charakterystyczna $V_{Rk,s}^0$ [kN]	6,5			10,6			18,9			29,5			51,0			3)		
HSA-R2, HSA-R																		
Nośność charakterystyczna $V_{Rk,s}^0$ [kN]	7,2			12,3			22,6			29,3			56,5			91,9		
Zniszczenie stali z oddziaływaniem momentu zginającego																		
Częściowy współczynnik bezpieczeństwa $\gamma_{Ms}^{2)}$ [-]	1,25																	
Współczynnik ciągliwości k_7	1,0																	
HSA, HSA-BW																		
Charakterystyczny moment zginający $M_{Rk,s}^0$ [Nm]	9,9			21,7			48,6			91,7			216			454		
HSA-F																		
Charakterystyczny moment zginający $M_{Rk,s}^0$ [Nm]	9,9			21,7			48,6			91,7			216			3)		
HSA-R2, HSA-R																		
Charakterystyczny moment zginający $M_{Rk,s}^0$ [Nm]	9,9			21,0			48,6			76,0			200			406		
Zniszczenie przez podważenie betonu																		
Montażowy współczynnik bezpieczeństwa γ_{inst} [-]	1,0																	
Współczynnik dla podważenia betonu k_8	1	2		1	1,5	2	2,4			2			2,9			2		3,5
Zniszczenie krawędzi podłoża betonowego																		
Montażowy współczynnik bezpieczeństwa γ_{inst} [-]	1,0																	
Czynna długość kotwy l_f [mm]	30	40	60	30	40	70	40	50	80	50	65	100	65	80	120	75	100	115
Czynna zewnętrzna średnica kotwy d_{nom} [mm]	6			8			10			12			16			20		

¹⁾ Zastosowanie jest ograniczone do wykonywania zakotwień statycznie niewyznaczalnych elementów konstrukcji oraz do warunków suchych panujących wewnątrz budowli.

²⁾ W przypadku braku innych przepisów krajowych.

³⁾ Nie wykonano oceny.

Metalowa kotwa rozporowa Hilti HSA

Charakterystyka produktu

Nośność charakterystyczna pod wpływem obciążeń ścinających w betonie niespękanym

Załącznik C2

Tabela C3: Przemieszczenia pod wpływem obciążeń rozciągających i ścinających w betonie niezarysowanym

Rozmiar kotwy		M6			M8			M10			M12			M16			M20		
Pozycja osadzania		①	②	③	①	②	③	①	②	③	①	②	③	①	②	③	①	②	③
Czynna głębokość zakotwienia	h_{ef} [mm]	30	40	60	30	40	70	40	50	80	50	65	100	65	80	120	75	100	115
Przemieszczenia pod wpływem obciążeń rozciągających																			
Siła rozciągająca	N [kN]	2,9	3,6	4,3	4,0	6,1	7,6	6,1	8,5	11,9	8,5	12,6	16,7	12,6	17,2	23,8	16,6	25,1	30,8
Odpowiednie przemieszczenie	δ_{N0} [mm]	0,2	0,6	1,0	0,2	1,2	1,8	0,4	1,1	2,0	0,3	1,4	2,3	0,4	1,3	2,1	0,1	0,8	1,9
	$\delta_{N\infty}$ [mm]	0,6	1,0	1,4	0,6	1,6	2,2	0,8	1,5	2,4	0,7	1,8	2,7	0,8	1,7	2,5	0,5	1,2	2,3
Przemieszczenia pod wpływem obciążeń ścinających																			
Siła ścinająca	V [kN]	3,7			6,1			10,8			16,7			29,1			49,0		
Odpowiednie przemieszczenie	δ_{V0} [mm]	1,6			1,9			2,0			2,1			2,2			2,3		
	$\delta_{V\infty}$ [mm]	2,4			2,9			3,0			3,2			3,3			3,5		

Metalowa kotwa rozporowa Hilti HSA

Charakterystyka produktu

Przemieszczenia pod wpływem obciążeń rozciągających i ścinających w betonie niespękanym

Załącznik C3