



The following pages are an excerpt from the North American Product Technical Guide, Volume 1: Direct Fastening Technical Guide, Edition 24.

Please refer to the publication in its entirety for complete details on this product including data development, base materials, general suitability, installation, corrosion, and product specifications.

[Direct Fastening Technical Guide, Edition 24](#)

To consult directly with a team member regarding our direct fastening products, contact Hilti's team of technical support specialists between the hours of 7:00am - 5:00pm CST.

US: 877-749-6337 or HNATechnicalServices@hilti.com

CA: 1-800-363-4458 ext. 6 or CATechnicalServices@hilti.com

3.2.6 X-P PREMIUM CONCRETE FASTENERS AND X-U UNIVERSAL KNURLED SHANK FASTENERS

3.2.6.1 PRODUCT DESCRIPTION

The Hilti X-P Premium concrete fastener is a hardened fastener with 0.157" shank, optimized for performance in concrete applications, including high strength concrete.

The Hilti X-U universal knurled shank fastener is also a 0.157" shank fastener, designed to cover a wide range of application conditions in steel and concrete. With a fully knurled shank, the X-U fastener is particularly well-suited for steel applications.

To help ensure reliable fastenings, the X-P and X-U fasteners have matched tolerance to all Hilti powder-actuated tools using 8 mm fastener guides and drive pistons through an 8 mm nail head diameter and an 8 mm plastic guidance washer set near the nail tip. The X-U program also includes fasteners with pre-mounted steel washers of 15 mm or 36 mm.

Product features: X-P Fasteners

- Conical point, optimized for penetration in standard and tough concretes
- 0.157" shank for optimal tension and shear loads and stick rate
- Comes in 4 lengths, optimized for fastening of sheet metal (up to 16 ga.) to concrete
- Available in single or collated configurations for optimal productivity

Product features: X-U Fasteners

- Unique knurling design offering higher pullout strength and anchorage in steel
- A 0.157" shank diameter for high performance in both tension and shear applications
- Full range of fasteners in single or collated configurations to maximize productivity
- Recognized for horizontal wood deck diaphragms subjected to wind or seismic forces (Reference ICC-ES ESR-2269)

3.2.6.2 MATERIAL SPECIFICATIONS

Fastener designation	Fastener material	Fastener plating	Fastener hardness
X-U	Carbon Steel	5 µm Zinc ¹	57.5 HRC
X-P	Carbon Steel	5 µm Zinc ¹	59 HRC

¹ ASTM B633, SC 1, Type III.

3.2.6.1 Product description

3.2.6.2 Material specifications

3.2.6.3 Technical data

3.2.6.4 Perimeter wall application fasteners

3.2.6.5 Ordering information

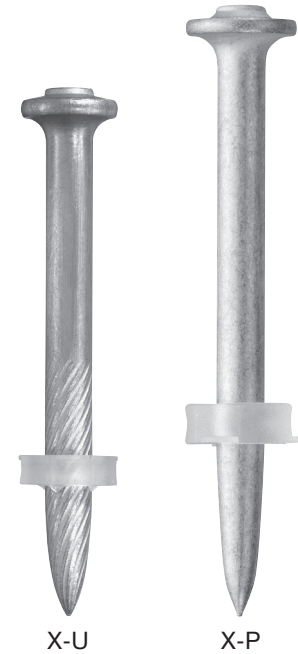

Listings/Approvals

ICC-ES (International Code Council)
ESR-2269 with LABC/LARC Supplement



3.2.6.3 TECHNICAL DATA

Ultimate loads in normal weight concrete^{1, 2}

Fastener	Shank diameter in. (mm)	Minimum embedment in. (mm)	Concrete compressive strength							
			2000 psi		4000 psi		6000 psi		8000 psi	
			Tension lb (kN)	Shear lb (kN)	Tension lb (kN)	Shear lb (kN)	Tension lb (kN)	Shear lb (kN)	Tension lb (kN)	Shear lb (kN)
X-U Universal Fastener	0.157 (4.0)	3/4 (19)	570 (2.5)	840 (3.7)	705 (3.1)	765 (3.4)	790 (3.5)	1020 (4.5)	-	-
		1 (25)	855 (3.8)	1060 (4.7)	995 (4.4)	1380 (6.1)	1135 (5.1)	1630 (7.3)	-	-
		1-1/4 (32)	1225 (5.5)	1865 (8.3)	1500 (6.7)	2020 (9.0)	1300 (5.8)	2325 (10.3)	-	-
		1-1/2 (38)	1765 (7.9)	2480 (11.0)	1965 (8.7)	2250 (10.0)	-	-	-	-
X-P Premium Concrete Fastener	0.157 (4.0)	3/4 (19)	535 (2.4)	980 (4.4)	800 (3.6)	1430 (6.4)	735 (3.3)	1575 (7.0)	875 (3.9)	1475 (6.6)
		1 (25)	880 (3.9)	1395 (6.2)	1345 (6.0)	1710 (7.6)	1320 (5.9)	2040 (9.1)	1400 (6.2)	1820 (8.1)
		1-1/4 (32)	1535 (6.8)	2060 (9.2)	1865 (8.3)	2210 (9.8)	1650 (7.3)	2350 (10.5)	-	-
		1-1/2 (38)	2005 (8.9)	2280 (10.1)	-	-	-	-	-	-

Allowable loads in normal weight concrete^{1, 2}

Fastener	Shank diameter in. (mm)	Minimum embedment in. (mm)	Concrete compressive strength							
			2000 psi		4000 psi		6000 psi		8000 psi	
			Tension lb (kN)	Shear lb (kN)	Tension lb (kN)	Shear lb (kN)	Tension lb (kN)	Shear lb (kN)	Tension lb (kN)	Shear lb (kN)
X-U Universal Fastener	0.157 (4.0)	3/4 (19)	100 (0.4)	125 (0.6)	100 (0.4)	125 (0.6)	105 (0.5)	205 (0.9)	-	-
		1 (25)	165 (0.7)	190 (0.8)	170 (0.8)	225 (1.0)	110 ³ (0.5)	280 ³ (1.2)	-	-
		1-1/4 (32)	240 (1.1)	310 (1.4)	280 (1.2)	310 (1.4)	180 (0.8)	425 (1.9)	-	-
		1-1/2 (38)	275 (1.2)	420 (1.9)	325 (1.4)	420 (1.9)	-	-	-	-
X-P Premium Concrete Fastener	0.157 (4.0)	3/4 (19)	100 (0.4)	155 (0.7)	100 (0.4)	175 (0.8)	105 (0.5)	205 (0.9)	135 (0.6)	205 (0.9)
		1 (25)	165 (0.7)	220 (1.0)	180 (0.8)	225 (1.0)	150 (0.7)	300 (1.3)	150 (0.7)	215 (1.0)
		1-1/4 (32)	240 (1.1)	310 (1.4)	280 (1.2)	310 (1.4)	180 (0.8)	425 (1.9)	-	-
		1-1/2 (38)	310 (1.4)	420 (1.9)	-	-	-	-	-	-

1 The tabulated load values are for the low-velocity fasteners only based on testing in accordance with ICC-ES AC 70 and ASTM E1190. Allowable loads are calculated based on a safety factor of at least 5.0. Some conditions like high wind loads, shock or fatigue may require a different safety factor. Wood or steel members connected to the substrate must be investigated in accordance with accepted design criteria.

2 Multiple fasteners are recommended for any attachment.

3 This allowable load value for the X-U fastener also applies to normal weight hollow core concrete slabs with f'c of 6600 psi and minimum face shell thickness of 1-3/8 in.

Ultimate and allowable loads in normal weight concrete using DX Kwik^{1, 2, 3}

Fastener	Shank diameter in. (mm)	Minimum embedment in. (mm)	Load type	Concrete compressive strength			
				4000 psi		6000 psi	
				Tension lb (kN)	Shear lb (kN)	Tension lb (kN)	Shear lb (kN)
X-U 47 P8 with DX Kwik	0.157 (4.0)	1-1/2 (38)	Ultimate	1973 (8.8)	2235 (9.9)	2101 (9.3)	2859 (12.7)
			Allowable	395 (1.8)	405 (1.8)	360 (1.6)	570 (2.5)

1 The tabulated ultimate load values are for the low-velocity fasteners only based on testing in accordance with ICC-ES AC 70 and ASTM E1190. Allowable loads are calculated based on a safety factor of at least 5.0. Some conditions like high wind loads, shock or fatigue may require a different safety factor. Wood or steel members connected to the substrate must be investigated in accordance with accepted design criteria.

2 Multiple fasteners are recommended for any attachment

3 X-U Fastener is installed using the DX Kwik drilled pilot hole installation procedure shown in section 3.2.1.10.

Ultimate loads in structural 3000 psi lightweight concrete^{1,4}

Fastener	Shank diameter in. (mm)	Minimum embedment in. (mm)	Fastener location							
			Installed into concrete		Installed through metal deck into concrete					
					3 inch deep composite floor deck ²			1-1/2 inch deep composite floor deck ³		
			Tension lb (kN)	Shear lb (kN)	Tension lb (kN)		Shear lb (kN)	Tension lb (kN)		Shear lb (kN)
Upper flute	Lower flute	Upper flute			Lower flute					
X-U Universal Fastener	0.157 (4.0)	3/4 (19)	627 (2.8)	747 (3.3)	649 (2.9)	483 (2.1)	1235 (5.5)	562 (2.5)	777 (3.5)	1862 (8.3)
		1 (25)	1037 (4.6)	1387 (6.2)	1083 (4.8)	774 (3.4)	1645 (7.3)	774 (3.4)	878 (3.9)	2079 (9.3)
		1-1/4 (32)	1581 (7.0)	2173 (9.7)	1464 (6.5)	848 (3.8)	1885 (8.4)	-	-	-
		1-1/2 (38)	2116 (9.4)	2524 (11.2)	2010 (8.9)	1292 (5.7)	2155 (9.6)	-	-	-
X-P Premium Concrete Fastener	0.157 (4.0)	3/4 (19)	785 (3.5)	1005 (4.5)	738 (3.3)	525 (2.3)	1530 (6.8)	705 (3.1)	840 (3.7)	1680 ⁵ (74.8)
		1 (25)	1245 (5.5)	1625 (7.2)	1120 (5.0)	840 (3.7)	1710 (7.6)	1310 (4.8)	1190 (5.3)	1935 ⁵ (86.1)
		1-1/4 (32)	1720 (7.7)	2240 (10.0)	1985 (8.8)	1295 (5.8)	2025 (9.0)	-	1430 (6.4)	2675 ⁵ (11.9)
		1-1/2 (38)	2260 (10.1)	2465 (11.0)	2335 (10.4)	2015 (9.0)	1835 (8.2)	-	-	-

Allowable loads in structural 3000 psi lightweight concrete^{1,4}

Fastener	Shank diameter in. (mm)	Minimum embedment in. (mm)	Fastener location							
			Installed into concrete		Installed through metal deck into concrete					
					3 inch deep composite floor deck ²			1-1/2 inch deep composite floor deck ³		
			Tension lb (kN)	Shear lb (kN)	Tension lb (kN)		Shear lb (kN)	Tension lb (kN)		Shear lb (kN)
Upper flute	Lower flute	Upper flute			Lower flute					
X-U Universal Fastener	0.157 (4.0)	3/4 (19)	125 (0.6)	115 (0.5)	130 (0.6)	95 (0.4)	245 (1.1)	95 (0.4)	95 (0.4)	370 (1.6)
		1 (25)	205 (0.9)	260 (1.2)	215 (1.0)	155 (0.7)	330 (1.5)	125 (0.6)	125 (0.6)	415 (1.8)
		1-1/4 (32)	315 (1.4)	435 (1.9)	295 (1.3)	200 (0.9)	375 (1.7)	-	-	-
		1-1/2 (38)	425 (1.9)	475 (2.1)	400 (1.8)	260 (1.2)	430 (1.9)	-	-	-
X-P Premium Concrete Fastener	0.157 (4.0)	3/4 (19)	155 (0.7)	165 (0.7)	130 (0.6)	105 (0.5)	285 (1.3)	140 (0.6)	130 (0.6)	335 ⁵ (14.9)
		1 (25)	225 (1.0)	300 (1.3)	215 (1.0)	165 (0.7)	340 (1.5)	215 (1.0)	215 (1.0)	385 ⁵ (17.2)
		1-1/4 (32)	325 (1.4)	445 (2.0)	295 (1.3)	230 (1.0)	375 (1.7)	-	270 (1.2)	465 ⁵ (2.1)
		1-1/2 (38)	425 (1.9)	480 (2.1)	400 (1.8)	330 (1.5)	365 (1.6)	-	-	-

1 The tabulated load values are for the low-velocity fasteners only based on testing in accordance with ICC-ES AC 70 and ASTM E1190. Allowable loads are calculated based on a safety factor of at least 5.0. Some conditions like high wind loads, shock or fatigue may require a different safety factor. Wood or steel members connected to the substrate must be investigated in accordance with accepted design criteria.

2 The steel deck profile for the 3" deep composite floor deck has a minimum thickness of 20 gauge (0.0358") and a minimum Fy = 33 ksi. Lower and upper flute width must be a minimum of 3-7/8". Figure 1 in Section 3.2.1.6 shows the nominal flute dimensions, fastener locations and load orientations for the deck profile. Structural lightweight concrete fill above top of steel deck must be minimum 3-1/4".

3 The steel deck profile for the 1-1/2" deep composite floor deck has a minimum thickness of 20 gauge (0.0358") and a minimum Fy = 33 ksi. Lower flute and upper flute widths must be a minimum of 1-3/4" and 3-1/2", respectively. This deck may also be inverted as shown in Figure 3 in Section 3.2.1.6. Figures 2 and 3 in Section 3.2.1.6 show the nominal flute dimensions, fastener locations and load orientations for the deck profile. Structural lightweight concrete fill above top of steel deck must be minimum 2-1/2".

4 Multiple fasteners are recommended for any attachment.

5 For installation in the lower flute only.

Ultimate and allowable loads in concrete masonry units ^{1, 2, 3, 4, 5, 10}

Fastener	Shank diameter in. (mm)	Minimum embedment in. (mm)	Load type	Hollow CMU			
				Face shell ⁶		Mortar joint ⁶	
				Tension lb (kN)	Shear lb (kN)	Tension lb (kN)	Shear ⁷ lb (kN)
X-U	0.157 (4.0)	1 (25)	Ultimate	449 (2.0)	524 (2.3)	244 (1.1)	483 (2.1)
			Allowable	70 (0.3)	85 (0.4)	25 (0.1)	70 (0.3)

Fastener	Shank diameter in. (mm)	Minimum embedment in. (mm)	Load type	Grout-filled CMU					
				Face shell ⁶		Mortar joint ⁶		Top of grouted cell ⁸	
				Tension lb (kN)	Shear ⁷ lb (kN)	Tension lb (kN)	Shear ⁷ lb (kN)	Tension lb (kN)	Shear ⁷ lb (kN)
X-U	0.157 (4.0)	1 (25)	Ultimate	1124 (5.0)	1093 (4.9)	920 (4.1)	993 (4.4)	935 (4.2)	1194 (5.3)
			Allowable	225 (1.0)	220 (1.0)	150 (0.7)	190 (0.8)	165 (0.7)	240 (1.1)

- 1 The tabulated allowable and ultimate load values are for the low-velocity fasteners only based on testing in accordance with ICC-ES AC 70 and ASTM E1190. Allowable loads are calculated based on a safety factor of at least 5.0. Some conditions like high wind loads, shock or fatigue may require a different safety factor.
- 2 The tabulated allowable and ultimate load values are for low-velocity fasteners installed in normal weight or lightweight concrete masonry units conforming to ASTM C90.
- 3 The tabulated allowable and ultimate load values are for low-velocity fasteners installed in concrete masonry units with mortar conforming to ASTM C270, Type S.
- 4 The tabulated allowable and ultimate load values are for low-velocity fasteners installed in concrete masonry units with grout conforming to ASTM C476.
- 5 The tabulated allowable and ultimate load values are for one low-velocity fastener installed in an individual masonry unit cell and at least 4" from the edge of the wall.
- 6 Fastener can be located anywhere on the face shell or mortar joints as shown in the figure below.
- 7 Shear load direction can be horizontal or vertical (Bed Joint or T-Joint) along the CMU wall plane.
- 8 Fastener located in center of grouted cell installed vertically.
- 9 Shear load can be in any direction in top of grouted cell application.
- 10 Multiple fasteners are recommended for any attachment.

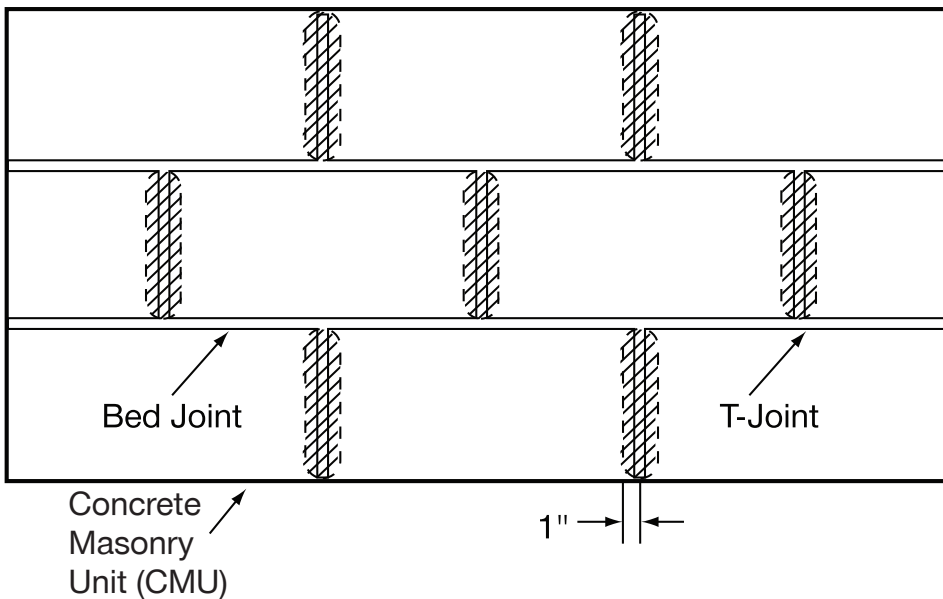

Acceptable Locations (NON-SHADED AREAS) for X-U Universal Knurled Shank Fasteners in CMU Walls

Ultimate and allowable loads in minimum ASTM A36 ($F_y \geq 36$ ksi; $F_u \geq 58$ ksi) steel^{1,2,4,5}

Fastener	Shank diameter in. (mm)	Load type	Steel thickness in.			
			3/16		1/4	
			Tension lb (kN)	Shear lb (kN)	Tension lb (kN)	Shear lb (kN)
X-U	0.157 (4.0)	Ultimate	2872 (12.8)	3939 (17.5)	4170 (18.6)	3886 (17.3)
		Allowable	500 ⁶ (2.4)	720 (3.2)	775 ⁶ (3.4)	720 (3.2)

Fastener	Shank diameter in. (mm)	Load type	Steel thickness in.					
			3/8		1/2		$\geq 3/4^3$	
			Tension lb (kN)	Shear lb (kN)	Tension lb (kN)	Shear lb (kN)	Tension lb (kN)	Shear lb (kN)
X-U	0.157 (4.0)	Ultimate	5688 (25.3)	4426 (19.7)	4690 (20.9)	3761 (16.7)	1899 (8.5)	2046 (9.1)
		Allowable	935 (4.2)	720 (3.2)	900 (4.0)	720 (3.2)	350 (1.6)	375 (1.7)

- The tabulated ultimate load values are for the low-velocity fasteners only based on testing in accordance with ICC-ES AC 70 and ASTM E1190. Allowable loads are calculated based on a safety factor of at least 5.0. Some conditions like high wind loads, shock or fatigue may require a different safety factor.
- Low-velocity fasteners shall be driven to where the point of the fastener penetrates through the steel base material, except as noted.
- Tabulated ultimate load values provided for $\geq 3/4$ " steel are based upon minimum point penetration of 1/2" into the steel. If 1/2" point penetration into the steel is not achieved, but a point penetration of at least 3/8" is obtained, the tabulated tension value should be reduced by 20% and the tabulated shear value should be reduced by 8%.
- Multiple fasteners are recommended for any attachment
- When used for resisting seismic forces, allowable loads are valid as per ICC-ES AC70, Annex A
- For fastening of cold-formed sheet steel, up to 16 gauge, for static loads only, when designed in accordance with AISI S100 (Section J5.2): The tabulated allowable load may be increased by a factor of 1.25, and the design strength may be taken as the tabulated allowable load multiplied by a factor of 2.0.

Allowable tensile pullover and shear bearing load capacities for steel framing with X-P and X-U
Powder-Actuated Fasteners^{1,2,3,4}

Fastener description	Fastener	Head diameter in. (mm)	Sheet steel thickness							
			14 ga.		16 ga.		18 ga.		20 ga.	
			Tension lb (kN)	Shear lb (kN)	Tension lb (kN)	Shear lb (kN)	Tension lb (kN)	Shear lb (kN)	Tension lb (kN)	Shear lb (kN)
0.157" shank with or without plastic washers or MX collation	X-U X-P	0.322 (8.2)	825 (3.67)	1,085 (4.83)	685 (3.05)	720 (3.20)	490 (2.18)	525 (2.34)	360 (1.60)	445 (1.98)

Fastener description	Fastener	Head diameter in. (mm)	Sheet steel thickness					
			22 ga.		24 ga.		25/26 ga.	
			Tension lb (kN)	Shear lb (kN)	Tension lb (kN)	Shear lb (kN)	Tension lb (kN)	Shear lb (kN)
0.157" shank with or without plastic washers or MX collation	X-U X-P	0.322 (8.2)	300 (1.33)	330 (1.47)	205 (0.91)	255 (1.13)	120 (0.53)	145 (0.64)

- Allowable load values are based on a safety factor of 3.0.
- Allowable pullover capacities of sheet steel should be compared to allowable fastener tensile load capacities in concrete, steel, or masonry to determine controlling resistance load.
- Allowable shear load bearing capacities of sheet steel should be compared to allowable fastener shear capacities in concrete, steel or masonry to determine controlling resistance load.
- Data is based on the following minimum sheet steel properties, $F_y = 33$ ksi, $F_u = 45$ ksi (ASTM A653 material).

3.2.6.4.1 Application description
 3.2.6.4.2 Technical data

3.2.6.4 PERIMETER WALL APPLICATION FASTENERS

3.2.6.4.1 Application description

Perimeter wall applications as part of curtain walls and bypass balloon framing are common in steel and metal framed structures. Cold-formed steel framing and track encompass the outside perimeter of the building. Steel track is fastened directly or with other cold-formed steel components to steel framing members or to concrete slab edges. Insulation and/or cladding materials are then fastened to the steel track.

Product features: X-P Fasteners

Conical point, optimized for penetration in standard and tough concretes. 0.157" shank for optimal tension and shear performance. Comes in 4 lengths, optimized for fastening of sheet steel (up to 16 ga) to concrete. Available in single or collated configurations for optimal productivity.

Product features: X-U Fasteners

- Unique knurling design offering higher pullout strength and anchorage in steel.
- A 0.157" shank diameter for high performance in both tension and shear applications.
- For both X-U and X-P fasteners, full range of fasteners in single or collated configurations to maximize productivity.

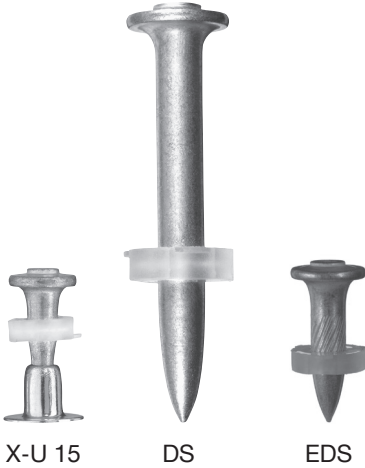
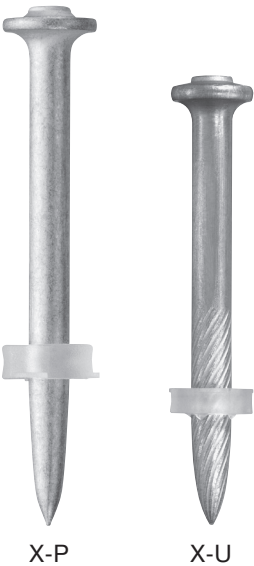

Perimeter wall track applications

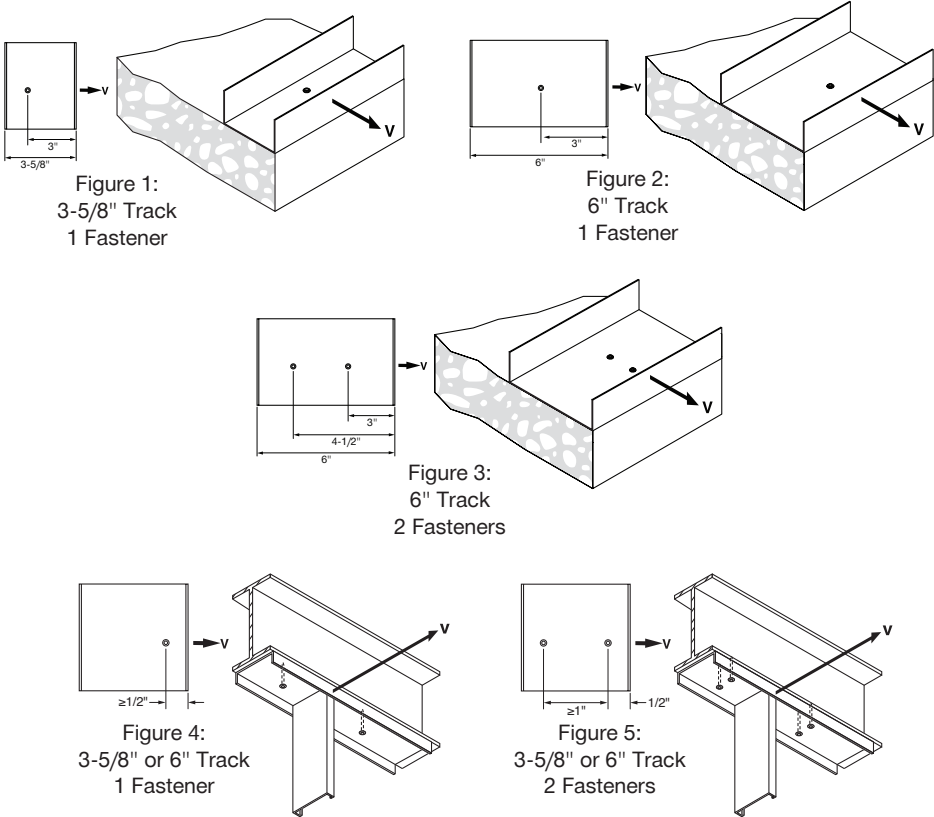

Listings/Approvals

ICC-ES (International Code Council)
 ESR-2269 with LABC/LARC Supplement
 (X-P, X-U and X-U 15)
 ESR-1663 with LABC/LARC Supplement
 (DS, EDS)



3.2.6.4.2 Technical data

Ultimate and allowable shear loads for attachment of perimeter track to 4000 psi normal weight concrete^{1, 2, 3, 4, 5, 6}

Fastener description	Shank diameter in. (mm)	Fastener length in. (mm)		Track width in. ⁷	Number of fasteners	Ultimate shear load lb (kN)		Allowable shear load lb (kN)	
X-U⁸ Universal Knurled Shank Fasteners and X-P⁸ Premium Concrete Fastener	0.157 (4.0)	1	(27)	3-5/8	1	1380	(6.1)	225	(1.0)
				6	1	1380	(6.1)	225	(1.0)
					2	3045	(13.6)	450	(2.0)
		1-1/4	(32)	3-5/8	1	2020	(9.0)	275	(1.2)
				6	1	2020	(9.0)	275	(1.2)
					2	2760	(12.3)	550	(2.4)
DS⁹ Heavy Duty Fasteners	0.177 (4.5)	1	(27)	3-5/8	1	1200	(5.3)	240	(1.1)
				6	1	1200	(5.3)	240	(1.1)
					2	2750	(12.2)	480	(2.1)
		1-1/4	(32)	3-5/8	1	2125	(9.5)	350	(1.6)
				6	1	2125	(9.5)	350	(1.6)
					2	-	-	-	-

1 The tabulated ultimate loads were developed from testing the low-velocity fasteners with 16 gauge (Fy ≥ 33 ksi) steel track. A safety factor greater than or equal to 5.0 was used to determine allowable loads. Steel track members not meeting the specification noted must be investigated in accordance with accepted design criteria

2 Allowable values are for fasteners installed in concrete having the designated compressive strength at the time of installation.

3 Spacing and edge distance constraints are as noted in Figures 1-3 on previous page 42.

4 Allowable shear load values are for loads applied perpendicular to the edge of the concrete.

5 Multiple fasteners are recommended for any attachment.

6 Minimum edge distance of 3" cannot be decreased. Closer edge distances can result in edge breakout failure of the base material during installation. As a result, fasteners are offset from the center line of the track.

7 SSMA track designation for 3-5/8" track is 362T 150-54 and for 6" track is 600T 150-54.

8 For additional technical data and materials specifications for X-U and X-P fasteners, see Section 3.2.6.2 and 3.2.6.3 of this Technical Guide

9 For additional technical data and materials specifications for DS fasteners, see section 3.2.5.

Ultimate and allowable shear loads for attachment of perimeter track to 3000 psi light weight concrete ^{1, 2, 3, 4, 5, 6}

Fastener description	Shank diameter in. (mm)	Fastener length in. (mm)	Track width in. ⁷	Number of fasteners	Ultimate shear load		Allowable shear load	
					lb (kN)		lb (kN)	
X-U⁸ Universal Knurled Shank Fasteners and X-P⁸ Premium Concrete Fastener	0.157 (4.0)	1 (27)	3-5/8	1	1290	(5.7)	260	(1.2)
			6	1	1290	(5.7)	260	(1.2)
				2	2585	(11.5)	520	(2.3)
		1-1/4 (32)	3-5/8	1	2173	(9.7)	350	(1.6)
				1	2173	(9.7)	350	(1.6)
			6	2	2885	(12.8)	575	(2.6)
				2	3020	(13.4)	605	(2.7)
		1-1/2 (37)	3-5/8	1	2524	(11.2)	295	(1.3)
				1	2524	(11.2)	295	(1.3)
			6	2	3020	(13.4)	605	(2.7)
2	3020			(13.4)	605	(2.7)		
DS⁹ Heavy Duty Fasteners	0.177 (4.5)	1 (27)	3-5/8	1	1020	(4.5)	205	(0.9)
			6	1	1020	(4.5)	205	(0.9)
				2	2995	(13.3)	600	(2.7)
		1-1/4 (32)	3-5/8	1	1120	(5.0)	225	(1.0)
				1	1120	(5.0)	225	(1.0)
			6	2	2965	(13.2)	595	(2.6)
				2	2965	(13.2)	595	(2.6)
		1-1/2 (37)	3-5/8	1	1075	(4.8)	215	(1.0)
				1	1075	(4.8)	215	(1.0)
			6	2	2955	(13.1)	590	(2.6)
2	2955			(13.1)	590	(2.6)		

1 The tabulated ultimate loads were developed from testing the low-velocity fasteners with 16 gauge (Fy ≥ 33 ksi) steel track. A safety factor greater than or equal to 5.0 was used to determine allowable loads. Steel track members not meeting the specification noted must be investigated in accordance with accepted design criteria

2 Allowable values are for fasteners installed in concrete having the designated compressive strength at the time of installation.

3 Spacing and edge distance constraints are as noted in Figures 1-3 on page 42.

4 Allowable shear load values are for loads applied perpendicular to the edge of the concrete.

5 Multiple fasteners are recommended for any attachment.

6 Minimum edge distance of 3" cannot be decreased. Closer edge distances can result in edge breakout failure of the base material during installation. As a result, fasteners are offset from the center line of the track.

7 SSMA track designation for 3-5/8" track is 362T 150-54 and for 6" track is 600T 150-54.

8 For additional technical data and material specifications for X-U and X-P fasteners, see Section 3.2.6.2 and 3.2.6.3 of this Technical Guide.

9 For additional technical data and material specifications for DS fasteners, see section 3.2.5 of this Technical Guide.

Allowable shear loads for attachment of perimeter track to minimum ASTM A36

($F_y \geq 36$ ksi; $F_u \geq 58$ ksi) steel, lb (kN)^{1,2,3,4}

Fastener description	Fastener	Shank diameter in. (mm)		Number of fasteners	Steel thickness (in.)									
					3/16 lb (kN)		1/4 lb (kN)		3/8 lb (kN)		1/2 lb (kN)		≥3/4 lb (kN)	
Universal knurled shank fasteners	X-U	0.157	(4.0)	1	720	(3.2)	720	(3.2)	720	(3.2)	720	(3.2)	375 ⁵	(1.7)
				2	1440	(6.4)	1440	(6.4)	1440	(6.4)	1440	(6.4)	750 ⁵	(3.3)
	X-U 15	0.145	(3.7)	1	395	(1.8)	395	(1.8)	450	(2.0)	500 ⁶	(2.2)	400 ⁶	(1.8)
				2	800	(3.6)	790	(3.5)	900	(4.0)	1000 ⁶	(4.5)	800 ⁶	(3.6)
Heavy duty fasteners	EDS	0.177	(4.5)	1	615	(2.7)	870	(3.9)	870	(3.9)	960	(4.3)	655 ⁷	(2.9)
				2	1230	(5.5)	1740	(7.7)	1740	(7.7)	1920	(8.5)	1310 ⁷	(5.8)

- The tabulated allowable load values are for the low-velocity fasteners only, using a safety factor that is greater than or equal to 5.0, calculated in accordance with ICC-ES AC70. Steel members connected to the substrate must be investigated in accordance with accepted design criteria.
- Low-velocity fasteners shall be driven to where the point of the fastener penetrates through the steel base material, except as noted.
- Multiple fasteners are recommended for increased reliability.
- The minimum edge distance for fastening into steel is 1/2". Minimum spacing for fastening into steel without reduction in performance is 1".
- Noted tabulated allowable load values are based upon minimum point penetration of 1/2" into the steel. If 1/2" point penetration into the steel is not achieved, but a point penetration of at least 3/8" is obtained, the tabulated shear load should be reduced by 8 percent.
- Noted tabulated allowable load values are based upon minimum point penetration into the steel of 15/32".
- Noted tabulated allowable load values are based upon a minimum point penetration into the steel of 1/2".

Deflection slip clip applications

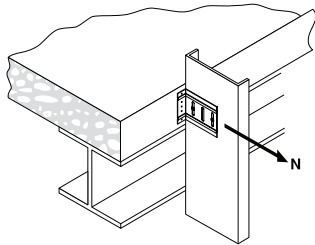

Figure 6:
Normal weight concrete

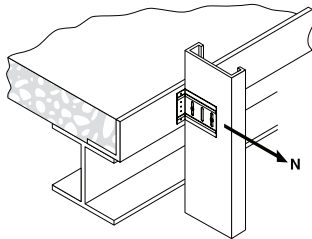

Figure 7:
Lightweight concrete with pour stop

Allowable loads for attachment of cold-formed steel deflection slip clips with X-U Universal Powder-Actuated Fasteners^{3,4,5,6,7,8,9}

Clip Type ¹⁰	Fastener	Number of fasteners	Normal weight concrete allowable load ¹ lb (kN)	Lightweight concrete with pour stop allowable load ² lb (kN)	Location of fasteners
Verticlip® SLB600 (14 GA.)	X-U 27	2	160 (0.7)	160 (0.7)	
		3	245 (1.1)	245 (1.1)	
		4	330 (1.5)	380 (1.7)	
WSC 950 (16 GA.)	X-U 27	2	125 (0.6)	155 (0.7)	
		3	145 (0.6)	275 (1.2)	
		4	220 (1.0)	275 (1.2)	
WSC 1500 (12 GA.)	X-U 27	2	90 (0.4)	130 (0.6)	
		3	185 (0.8)	235 (1.1)	
FCSC™ (14 GA.)	X-U 27	2	140 (0.6)	170 (0.8)	
		3	290 (1.3)	320 (1.4)	

- Allowable load based on a safety factor of 5.0 in direction shown in Figure 6 for attachment of deflection slip clip to 4000 psi Normal Weight Concrete Slab.
- Allowable load based on a safety factor of 5.0 in direction shown in Figure 7 for attachment of deflection slip clip to 3000 psi Lightweight Concrete Slab with 12 GA. sheet steel pour stop with minimum yield strength $F_y = 33$ ksi.
- Testing based on deflection slip clips obtained in February 2007. Subsequent changes by the manufacturer to the deflection slip clip design may affect load values.
- Allowable load values are for fasteners installed in concrete having the designated compressive strength at the time of installation.
- Allowable load values are based off of the fixtures tested. Other members connected to the deflection slip clips must be investigated in accordance with accepted design criteria.
- Spacing of fasteners depends on the design of each deflection slip clip. Fasteners should be installed through the pre-assigned locations in the deflection slip clip.
- For base material thickness requirements, reference Section 3.2.1.4.
- Allowable values are for loads applied perpendicular to the edge of the concrete.
- Multiple fasteners are recommended for any attachment.
- Verticlip is a registered trademark of The Steel Network, Inc. Fast Clip Slide Clip (FCSC) is a trademark of Ware Industries Inc.

Allowable loads for attachment of cold-formed steel deflection slip clips with X-U Universal Powder-Actuated Fasteners to minimum ASTM A36

($F_y \geq 36$ ksi; $F_u \geq 58$ ksi) steel^{1,2,3,4,5,6,7,8}

Clip type	Fastener	Number of fasteners	Allowable load lb (kN)	Location of fasteners
Verticlip SLB600 (14 GA.)	X-U 16	2	740 (3.3)	
	X-U 19	3	1490 (6.6)	
	EDS 19	3	1490 (6.6)	
	EDS 22	4	2115 (9.4)	
WSC 950 (16 GA.)	X-U 16	2	510 (2.3)	
	X-U 19	3	610 (2.7)	
	EDS 19	3	610 (2.7)	
	EDS 22	4	870 (3.9)	
WSC 1500 (12 GA.)	X-U 16	2	970 (4.3)	
	X-U 19	3	1105 (4.9)	
	EDS 19	3	1105 (4.9)	
	EDS 22	4	1300 (5.8)	
FCSC (14 GA.)	X-U 16	2	715 (3.2)	
	X-U 19	3	940 (4.2)	
	EDS 19	3	940 (4.2)	
	EDS 22	4	1055 (4.7)	

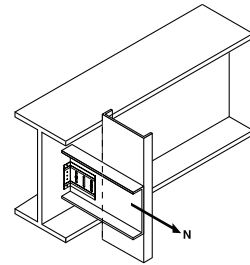

Figure 8: Steel

- 1 Allowable load based on a variable safety factor in accordance with Section K of AISI S100.
- 2 Testing based on deflection slip clips developed in February 2007. Subsequent changes by the deflection slip clip manufacturer to the clip design may affect load values.
- 3 Allowable load values are based off of the connections tested. Steel members connected to the deflection slip clips must be investigated in accordance with accepted design criteria.
- 4 Spacing of fasteners depends on the design of each deflection slip clip. Fasteners should be installed through the pre-assigned locations in the deflection slip clip.
- 5 For edge distance requirement reference Section 3.2.2.2.
- 6 Allowable load values are for loads applied perpendicular to the edge of the base steel member.
- 7 Multiple fasteners are recommended for any attachment.
- 8 Allowable load values are based on testing into 1/4" ASTM A36 structural steel. Allowable load in other base steel thicknesses can be calculated as single fastener allowable load (Tension) x number of fasteners. Reference Table "Ultimate and Allowable Loads in Minimum ASTM A36 ($F_y \geq 36$ ksi; $F_u \geq 58$ ksi) Steel" on page 41 for single fastener allowable loads in specific steel thickness. Calculated allowable load should be compared with the relevant allowable load in this table to determine controlling resistance load.

3.2.6.5 ORDERING INFORMATION

Fastener description	Shank length in. (mm)	Shank Ø in. (mm)	Washer Ø	Packaging Qty
X-P 22	7/8 (22)	0.157 (4.0)	Plastic 8 mm or collated	100 pcs/ box
X-P 27	1 (27)	0.157 (4.0)	Plastic 8 mm or collated	100 pcs/ box
X-P 34	1 1/4 (34)	0.157 (4.0)	Plastic 8 mm or collated	100 pcs/ box
X-P 40	1 5/8 (40)	0.157 (4.0)	Plastic 8 mm or collated	100 pcs/ box
X-U 16	5/8 (16)	0.157 (4.0)	Plastic 8 mm or collated	100 pcs / box
X-U 19	3/4 (19)	0.157 (4.0)	Plastic 8 mm or collated	100 pcs / box
X-U 22	7/8 (22)	0.157 (4.0)	Plastic 8 mm or collated	100 pcs / box
X-U 27	1 (27)	0.157 (4.0)	Plastic 8 mm or collated	100 pcs / box
X-U 32	1-1/4 (32)	0.157 (4.0)	Plastic 8 mm or collated	100 pcs / box
X-U 37	1-1/2 (37)	0.157 (4.0)	Plastic 8 mm or collated	100 pcs / box
X-U 42	1-5/8 (42)	0.157 (4.0)	Plastic 8 mm or collated	100 pcs / box
X-U 47	1-7/8 (47)	0.157 (4.0)	Plastic 8 mm or collated	100 pcs / box
X-U 52	2 (52)	0.157 (4.0)	Plastic 8 mm or collated	100 pcs / box
X-U 57	2-1/4 (57)	0.157 (4.0)	Plastic 8 mm or collated	100 pcs / box
X-U 62	2-1/2 (62)	0.157 (4.0)	Plastic 8 mm or collated	100 pcs / box
X-U 72	2-7/8 (72)	0.157 (4.0)	Plastic 8 mm or collated	100 pcs / box
X-U 22 P8 S15	7/8 (22)	0.157 (4.0)	Plastic 8 mm & Steel 15 mm	100 pcs / box
X-U 27 P8 S15	1 (27)	0.157 (4.0)	Plastic 8 mm & Steel 15 mm	100 pcs / box
X-U 32 P8 S15	1-1/4 (32)	0.157 (4.0)	Plastic 8 mm & Steel 15 mm	100 pcs / box
X-U 32 P8 S36	1-1/4 (32)	0.157 (4.0)	Plastic 8 mm & Steel 36 mm	100 pcs / box
X-U 72 P8 S36	2-7/8 (72)	0.157 (4.0)	Plastic 8 mm & Steel 36 mm	100 pcs / box
X-U 16 P8 TH	5/8 (16)	0.157 (4.0)	8 mm plastic & metal "tophat"	100 pcs / box
X-U 19 P8 TH	3/4 (19)	0.157 (4.0)	8 mm plastic & metal "tophat"	100 pcs / box
X-U 27 P8 TH	1 (27)	0.157 (4.0)	8 mm plastic & metal "tophat"	100 pcs / box



For ordering information on DS and EDS fasteners, please refer to the Hilti product catalog or visit www.hilti.com or www.hilti.ca