

# HILTI

## DX 35

**Bedienungsanleitung**

**de**

**Operating instructions**

**en**

**Mode d'emploi**

**fr**

**Manual de instrucciones**

**es**



1

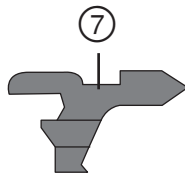
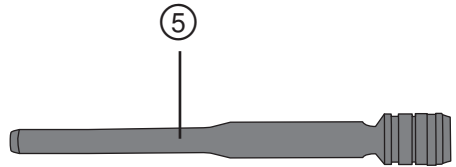
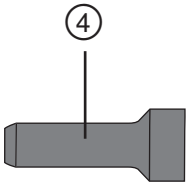
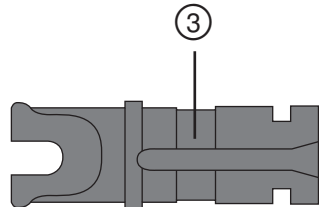
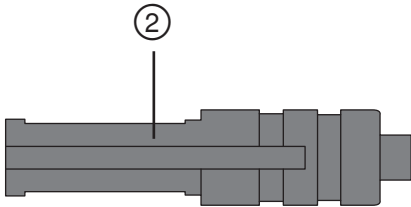
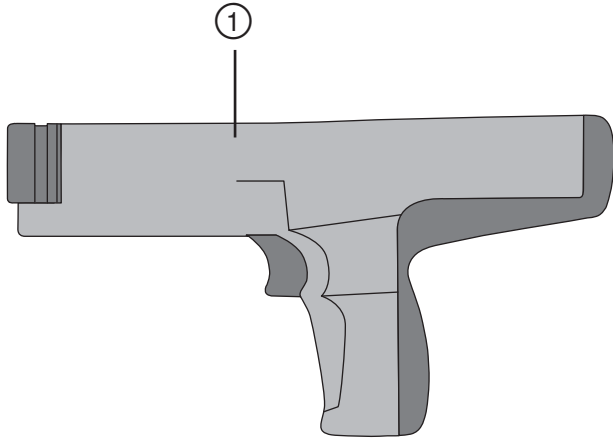

2

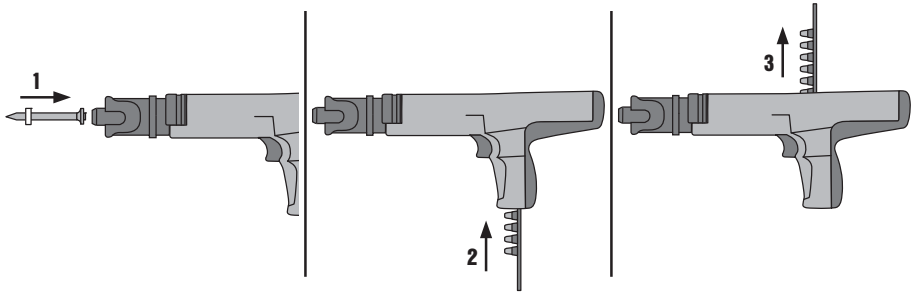

3

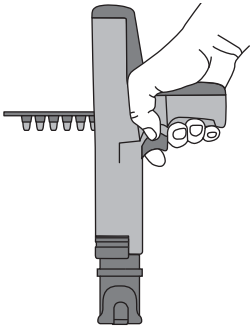

4

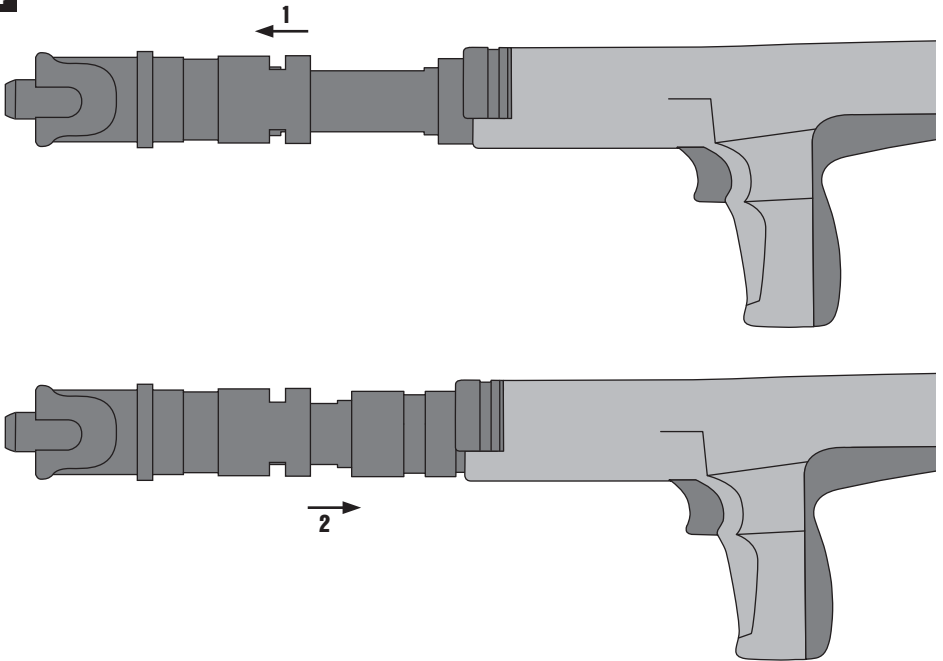

5

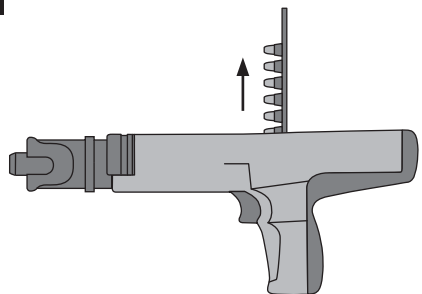

6

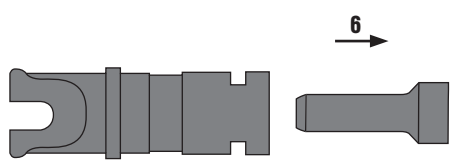
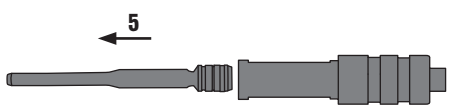
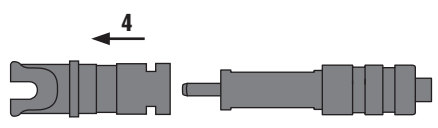
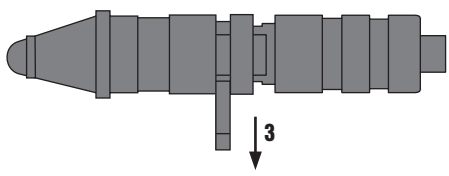
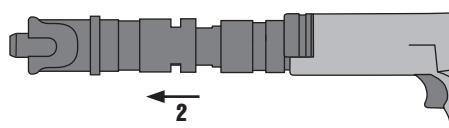
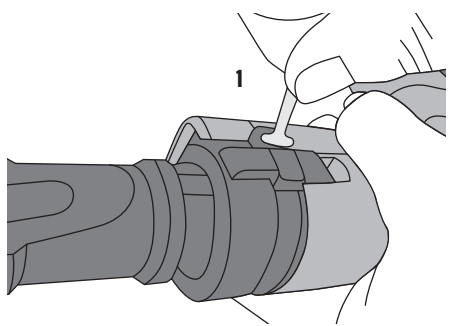

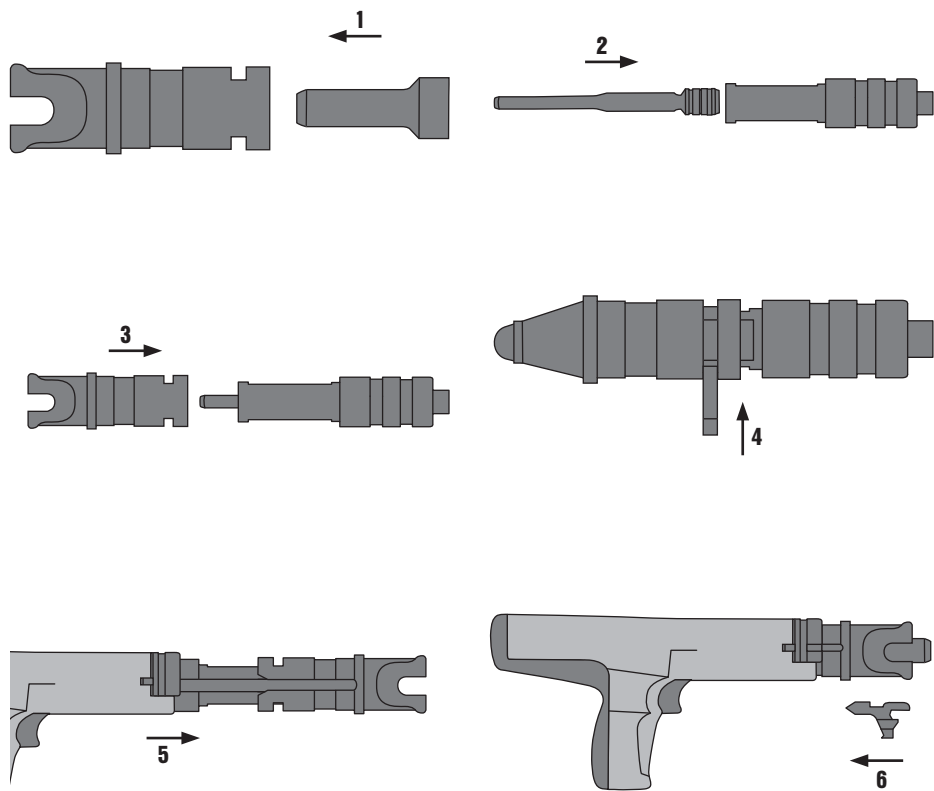

## ORIGINAL OPERATING INSTRUCTIONS

# DX 35 powder-actuated fastening tool

**It is essential that the operating instructions are read before the tool is operated for the first time.**

**Always keep these operating instructions together with the tool.**

**Ensure that the operating instructions are with the tool when it is given to other persons.**

Contents	Page
1 Safety instructions	17
2 General information	19
3 Description	20
4 Accessories, consumables	21
5 Technical data	22
6 Before use	22
7 Guidelines	22
8 Operation	23
9 Care and maintenance	24
10 Troubleshooting	26
11 Disposal	30
12 Manufacturer's warranty - tools	30
13 EC declaration of conformity (original)	31
14 Confirmation of CIP testing	31
15 Health and safety of the operator	31

■ These numbers refer to the corresponding illustrations. The illustrations can be found on the fold-out cover pages. Keep these pages open while studying the operating instructions.

In these operating instructions, the designation "the tool" always refers to the DX 35 powder-actuated fastening tool.

### Parts and operating controls ■

- ① Casing
- ② Piston guide
- ③ Base plate
- ④ Fastener guide
- ⑤ Piston
- ⑥ Spring clip
- ⑦ Catch
- ⑧ Stabilizer (fragmentation guard, only USA)

## 1 Safety instructions

### 1.1 Basic information concerning safety

**In addition to the information relevant to safety given in each of the sections of these operating instructions, the following points must be strictly observed at all times.**

#### 1.1.1 Using cartridges

**Use only Hilti cartridges or cartridges of equivalent quality.**

Use of cartridges of inferior quality in Hilti tools may lead to a build-up of unburned powder, which may explode and cause severe injuries to operators and bystanders. Cartridges must fulfill one of the following minimum requirements:

- a) **The applicable manufacturer must be able to verify successful testing in accordance with the EU standard EN 16264 or**
- b) **The cartridges must bear the CE conformity mark (mandatory in the EU as of July 2013).**

#### NOTE

All Hilti cartridges for powder-actuated tools have been tested successfully in accordance with EN 16264. The tests defined in the EN 16264 standard are system tests

carried out by the certification authority using specific combinations of cartridges and tools. The tool designation, the name of the certification authority and the system test number are printed on the cartridge packaging.

Please refer to the packaging example at: [www.hilti.com/dx-cartridges](http://www.hilti.com/dx-cartridges)

#### 1.1.2 Requirements to be met by users

- a) **The tool is intended for professional use.**
- b) **The tool may be operated, serviced and repaired only by authorized, trained personnel. This personnel must be informed of any special hazards that may be encountered.**

#### 1.1.3 Personal safety

- a) **Stay alert, watch what you are doing and use common sense when operating a direct fastening tool. Don't use the tool when you are tired or under the influence of drugs, alcohol or medication. Stop using the tool if you experience pain or do not feel well. A moment of inattention while operating the tool may result in serious personal injury.**

en

- b) **Avoid unfavorable body positions. Make sure you work from a safe stance and stay in balance at all times.**
- c) **Wear non-skid shoes.**
- d) **Never point the tool toward yourself or other persons.**
- e) **Never press the nosepiece of the tool against your hand or against any other part of your body (or other person's hand or part of their body).**
- f) **Keep other persons, especially children, away from the area in which the work is being carried out.**
- g) **Keep the arms slightly bent while operating the tool (do not straighten the arms).**
- h) **Observe the information printed in the operating instructions concerning operation, care and maintenance.**

#### 1.1.4 Use and care of powder-actuated fastening tools

- a) **Use the right tool for the job. Do not use the tool for purposes for which it was not intended. Use it only as directed and when in faultless condition.**
- b) **Never leave a loaded tool unattended.**
- c) **Store unused cartridges and tools currently not in use in a dry place where they are not exposed to high temperatures.**
- d) **Transport and store the tool in a toolbox that can be secured to prevent unauthorized use.**
- e) **Always unload the tool (remove cartridges and fasteners) before cleaning, before maintenance, before work breaks and before storing the tool.**
- f) **When not in use, tools must be unloaded and stored in a dry place, locked up or out of reach of children.**
- g) **Check the tool and its accessories for any damage. Guards, safety devices and any slightly worn parts must be checked carefully to ensure that they function faultlessly and as intended. Check that moving parts function correctly without sticking and that no parts are damaged. All parts must be fitted correctly and fulfill all conditions necessary for correct operation of the tool. Damaged guards, safety devices and other parts must be repaired or replaced properly at a Hilti service center unless otherwise indicated in the operating instructions.**
- h) **Pull the trigger only when the tool is fully pressed against the working surface at right angles.**
- i) **Always hold the tool securely and at right angles to the working surface when driving in fasteners. This will help to prevent fasteners being deflected by the working surface.**
- j) **Never redrive a fastener. This may cause the fastener to break and the tool may jam.**
- k) **Never drive fasteners into existing holes unless this is recommended by Hilti.**
- l) **Always observe the application guidelines.**

#### 1.1.5 Work area safety



- a) **Ensure that the workplace is well lit.**
- b) **Operate the tool only in well-ventilated working areas.**
- c) **Do not attempt to drive fasteners into unsuitable materials:** Materials that are too hard, e.g. welded steel and cast iron. Materials that are too soft, e.g. wood and drywall panel (gypsum board). Materials that are too brittle, e.g. glass and ceramic tiles. Driving a fastener into these materials may cause the fastener to break, shatter or to be driven right through.
- d) **Never attempt to drive fasteners into materials such as glass, marble, plastic, bronze, brass, copper, rock, insulation material, hollow brick, ceramic brick, thin sheet metal (< 4 mm), cast iron or cellular concrete.**
- e) **Before driving fasteners, check that no one is present immediately behind or below the working surface.**
- f) **Keep the workplace tidy. Objects which could cause injury should be removed from the working area.** Untidiness at the workplace can lead to accidents.
- g) **Keep the grips dry, clean and free from oil and grease.**
- h) **Do not use the tool where there is a risk of fire or explosion unless it has been specially approved for use under these conditions.**

#### 1.1.6 Mechanical safety precautions



- a) **Select the correct fastener guide and fastener combination for the job on hand.** Failure to use the correct combination of these items may result in injury or cause damage to the tool and/or lead to unsatisfactory fastening quality.
- b) **Use only fasteners of a type approved for use with the tool.**
- c) **Do not tamper with or modify the tool or parts of it, especially the piston.**

#### 1.1.7 Thermal safety precautions

- a) **If the tool has overheated, allow it to cool down. Do not exceed the recommended fastener driving rate.**
- b) **If the tool has overheated, allow it to cool down.**
- c) **Do not dismantle the tool while it is hot. Allow the tool to cool down.**

- d) The tool must be allowed to cool down if the plastic cartridge strip begins to melt.

### 1.1.8 Danger of explosion



- a) Use only cartridges of a type approved for use with the tool.  
 b) Remove the cartridge strip from the tool carefully.  
 c) Do not attempt to forcibly remove cartridges from the magazine strip or tool.

- d) Store unused cartridges in a locked place where they are not exposed to dampness or excessively high temperatures.

### 1.1.9 Personal protective equipment



The user and any other persons in the vicinity must wear suitable eye protection, a hard hat and ear protection while the tool is in use or when remedying a problem with the tool.

en

## 2 General information

### 2.1 Safety notices and their meaning

#### DANGER

Draws attention to imminent danger that will lead to serious bodily injury or fatality.

#### WARNING

Draws attention to a potentially dangerous situation that could lead to serious personal injury or fatality.

#### CAUTION

Draws attention to a potentially dangerous situation that could lead to slight personal injury or damage to the equipment or other property.

#### NOTE

Draws attention to an instruction or other useful information.

### 2.2 Explanation of the pictograms and other information

#### Warning signs



General warning



Warning: explosive substances



Warning: hot surface

#### Obligation signs



Wear protective glasses



Wear a hard hat



Wear ear protection

### Symbols



Read the operating instructions before use

### Location of identification data on the tool

The type designation and serial number can be found on the type identification plate on the tool. Make a note of this data in your operating instructions and always refer to it when making an enquiry to your Hilti representative or service department.

Type: \_\_\_\_\_

Generation: 01 \_\_\_\_\_

Serial no.: \_\_\_\_\_



## 3 Description

### 3.1 Use of the product as directed

The tool is designed for professional use in fastening applications where nails, threaded studs and composite fasteners are driven into concrete, steel and sand-lime block masonry.

The tool is for hand-held use only.

Modification of the tool is not permissible.

The tool may not be used in an explosive or flammable atmosphere unless it has been approved for use under these conditions.

To avoid the risk of injury use only genuine Hilti fasteners, cartridges, accessories and spare parts or those of equivalent quality.

Observe the information printed in the operating instructions concerning operation, care and maintenance.

The tool and its ancillary equipment may present hazards when used incorrectly by untrained personnel or when used not as directed.

The tool may be operated, serviced and repaired only by trained personnel. This personnel must be informed of any special hazards that may be encountered.

As with all powder-actuated fastening tools, the tool, cartridges and fasteners form a technical unit. This means that trouble-free fastening with this system can be assured only if the Hilti fasteners and cartridges specially manufactured for it, or products of equivalent quality, are used. The fastening and application recommendations given by Hilti apply only when these conditions are observed.

The tool features a 5-way safety system for the safety of the user and all bystanders.

### 3.2 Piston principle

The energy from the propellant charge is transferred to a piston, the accelerated mass of which drives the fastener into the base material. Due to use of this piston principle, the tool is classified as a "low velocity tool". As approximately 95% of the kinetic energy is absorbed by the piston, the fastener is driven into the base material in a controlled fashion at much reduced velocity (less than 100 m/s). The fastener driving process ends when the piston reaches the end of its travel. Due to these technical measures, it is highly unlikely that through-shots will occur.

### 3.3 Drop-firing safety device

The drop-firing safety device is the result of coupling the firing mechanism with the cocking movement. This prevents the tool from firing when dropped onto a hard surface, no matter at which angle the impact occurs.

### 3.4 Trigger safety device

The trigger safety device prevents the tool firing when only the trigger is pulled. The tool must be pressed against a firm surface before a fastener can be released.

### 3.5 Contact pressure safety device

The tool can be fired only when pressed fully against a firm surface with a force of at least 50 N.

### 3.6 Unintentional firing safety device

The tool is also equipped with an unintentional firing safety device. This prevents the tool from firing if the trigger is first pulled and the tool then pressed against the work surface. The tool can be fired only when it is first pressed correctly against the work surface and the trigger subsequently pulled.

### 3.7 Range of fasteners available for various applications

#### Fasteners

Ordering designation	Application
X-U	High-strength nail for fastening on high-strength steel and concrete in a wide range of applications
X-C	Standard nail for fastening on concrete
X-S	Standard nail for efficient fastening on steel
X-CR	Stainless steel nail for fastening in damp or corrosive surroundings
X-FS C52	Fastener for positioning formwork

Ordering designation	Application
X-SW C37	Flexible washer fastener for fastening plastic sheeting and thin insulating materials to concrete and steel
X-HS / X-HS-W	Suspension system with threaded connection
X-CC	Fastening clip for wire hangers
X-(D)FB / X-EMTC	Metal conduit clip for fastening electrical conduits or insulated pipes (hot or cold) in water supply and heating installations
X-EKB	Cable clasp for fastening electric cables flat on ceilings and walls
X-ECH	Bunched cable holder for fastening cables on ceilings and walls
X-ET	Fastener for plastic (PVC) electric cable trunking
X-(E)M/W/6/8 ... P8	Threaded stud for temporary fastenings on concrete and steel
X-DNH / DKH X-M6/8H	Approved (ETA) DX-Kwik fastening system use on concrete with predrilling

#### Cartridges

Ordering designation	Color	Power level
6.3/10 M green	Green	Light
6.3/10 M yellow	Yellow	Medium
6.3/10 M red	Red	Heavy

## 4 Accessories, consumables

### NOTE

For information about further accessories and fasteners for use with the tool, please contact your local Hilti representative.

#### Safety accessories and cleaning set

Designation
Cleaning set
Hilti spray
Spring clip spare parts pack
Operating instructions
Stabilizer (fragmentation guard, only USA)
Additional baseplate
Spare part pack
Stop Gliss anti-slip paper

#### Standard accessories

Designation	Item number
Fastener guide 21/F3-1	2554
Baseplate 21/s1	2556
Piston 21/SDF	409298
Spring clip	2162

## 5 Technical data

Right of technical changes reserved.

Tool	DX 35
Weight	1.9 kg
Tool length	286 mm
Maximum fastener length	37 mm
Cartridges	6.3/10 M (25 cal. short) green, yellow, red
Recommended maximum fastening rate	300/h

en

## 6 Before use



### NOTE

Read the operating instructions before the tool is operated for the first time.

### 6.1 Checking the tool

#### WARNING

**Do not operate the tool when parts are damaged or when the controls do not function correctly. If necessary, have the tool repaired at an authorized Hilti service center.**

Check that no cartridge strip is loaded in the tool. If there is a cartridge strip in the tool, pull it up out of the tool by hand from above.

Check all external parts of the tool for damage and check that all controls operate faultlessly.

Check the piston and spring clip for wear and ensure that the parts have been fitted correctly.

## 7 Guidelines

### 7.1 Fastening guidelines

These guidelines must be observed at all times.

### NOTE

For detailed information, please ask your local Hilti sales and service office for a copy of the applicable technical guidelines or national technical regulations.

#### 7.1.1 Minimum distances and spacing

##### Minimum distances and spacing when fastening to steel

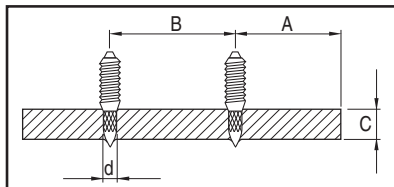

A min. edge distance = 15 mm ( $\frac{5}{8}$ "

B min. spacing = 20 mm ( $\frac{3}{4}$ "

C min. base material thickness = 4 mm ( $\frac{5}{32}$ "

## Minimum distances and spacing when fastening to concrete

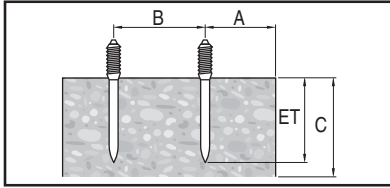

A min. edge distance = 70 mm (2¾")

b min. spacing = 80 mm (3⅛")

c min. base material thickness = 100 mm (4")

### 7.1.2 Depth of penetration

#### NOTE

Examples and specific information can be found in the Hilti Fastening Technology Manual.

#### Nail lengths for steel

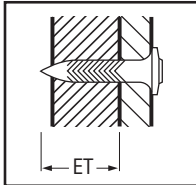

ET Depth of penetration: 12 ± 2 mm (½" ± ⅛")

#### Nail lengths for concrete

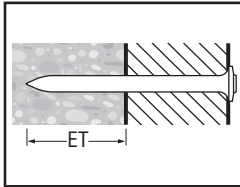

ET Depth of penetration: 22 mm (max. 27 mm) (7/8" (max. 1"))

## 8 Operation



#### WARNING

The material may splinter or fragments of the magazine strip may fly off when the fastener is driven. **The user of the tool and other persons in the immediate vicinity must wear protective glasses and a hard hat.** Splintering material presents a risk of injury to the eyes and body.

#### CAUTION

The fastener driving action is initiated by ignition of a propellant charge. **The user of the tool and other persons in the immediate vicinity must wear ear protectors.** Exposure to noise can cause hearing loss.

#### WARNING

Never make the tool ready to fire by pressing it against a part of the body (e.g. the hand). This could cause a nail

or the piston to be driven into a part of the body. **Never press the tool against a part of the body.**

#### WARNING

**Never redrive a fastener. This may cause the fastener to break and the tool may jam.**

#### WARNING

**Never drive fasteners into existing holes unless this is recommended by Hilti (e.g. DX-Kwik).**

#### CAUTION

**If the tool has overheated, allow it to cool down. Do not exceed the recommended fastener driving rate.**

### 8.1 Procedure if a cartridge fails to fire

If a cartridge fails to fire or misfires, always proceed as follows:

Keep the nose of the tool pressed at right angles against the working surface for 30 seconds.

If the cartridge still fails to fire, withdraw the tool from the working surface, taking care to avoid pointing it toward your body or toward bystanders.

Load the next cartridge on the strip by cycling the tool. Use up the remaining cartridges on the strip and remove the used cartridge strip from the tool. The (partly) used cartridge strip must then be disposed of appropriately to prevent further use or misuse of any unfired cartridges.

### 8.2 Loading the tool 2

1. Push the nail, head first, into the nose of the tool from the front until it is held in place in the tool by the washer on the nail.
2. Push the cartridge strip, narrow end first, into the grip of the tool from below until the full length of the cartridge strip is inside the grip.
3. If you wish to use a partly-used cartridge strip, pull the strip upwards by hand out of the tool slightly until the first unused cartridge is in place in the cartridge chamber.

### 8.3 Selecting the cartridge

1. Select the cartridge power level according to the application to be carried out.
2. If you cannot estimate this on the basis of previous experience, always begin with the lowest power. Select the weakest cartridge color and make a trial fastener placement.
3. Drive a nail.  
If the nail is not driven in deeply enough, try using a heavier cartridge.

### 8.4 Driving a fastener 3

#### WARNING

Always observe the safety rules listed in the operating instructions.

1. Press the tool against the working surface at right angles.
2. Drive the fastener by pulling the trigger.

### 8.5 Cycle the tool. 4

#### NOTE

If the cycling action (i.e. pulling out, pushing back in) is stiff, this indicates that the tool needs to be cleaned. Service the tool! (see section 9.3).

1. After driving a fastener, grip the collar at the nose of the tool between the thumb and forefinger.
2. Pull the nose unit forward in the main axis of the tool as far as it will go.
3. Then pull the fastener guide all the way back to its original position.  
This movement brings the piston back to its starting position and advances the cartridge strip to the next cartridge.  
The tool is then ready to drive the next fastener.

### 8.6 Unloading the tool 5

Check that there is no cartridge strip or fastener in the tool.

If there is a cartridge strip or fastener in the tool, pull the cartridge strip up out of the tool by hand from above and remove the fastener from the fastener guide.

## 9 Care and maintenance



#### CAUTION

When this type of tool is used under normal operating conditions, dirt and residues build up inside the tool and functionally relevant parts are also subject to wear. **Regular inspections and maintenance are thus essential in order to ensure reliable operation. We recommend that the tool is cleaned and the condition of the piston checked at least daily when the tool is subjected to intensive use, and at the latest after driving 3,000 fasteners.**

#### WARNING

**All cartridges must be removed from the tool. Check to ensure that no fastener is present in the fastener guide before carrying out maintenance or repairs.**

#### CAUTION

The tool may get hot during use. You could burn your hands. **Wear protective gloves when carrying out care and maintenance. Allow the tool to cool down.**

### 9.1 Care of the tool

Clean the outside of the tool at regular intervals with a slightly damp cloth.

#### WARNING

Do not clean with a spray or pressure washer. Do not permit foreign objects to enter the interior of the tool.

### 9.2 Maintenance

Check all external parts of the tool for damage at regular intervals and check that all controls operate faultlessly. Do not operate the tool if parts are damaged or when the controls do not function faultlessly. If necessary, the tool should be repaired by Hilti Service.

Use the tool only with the recommended cartridges. An incorrect cartridge selection can lead to a premature failure of parts of the tool.

#### CAUTION

Dirt and residues in DX tools contain substances that may be hazardous to your health. **Do not inhale dust / or dirt from cleaning. Keep the dust or dirt away from foodstuffs. Wash your hands after cleaning the tool. Never use grease for the maintenance/lubrication of parts of the tool. This may lead to malfunctions. Use only Hilti lubricant spray or a product of equivalent quality.**

### 9.3 Servicing the tool

Service the tool if fastener driving power is found to be inconsistent, if cartridges misfire or if parts of the tool no longer move or operate smoothly and easily. In other words, The required contact pressure increases, trigger resistance increases, the cartridge magazine strip can only be removed with a degree of difficulty or the cycling action becomes stiff.

#### 9.3.1 Disassembling the tool 6

#### CAUTION

Forcing the spring clip into place may cause it to jump off with considerable energy. **Take care to avoid injuring yourself or others. Hold the assembly with its back facing downwards.**

1. Lift the spring clip with a screwdriver or a nail and turn. Pull the stop backwards and remove.
2. Pull out the insert.
3. Press the spring clip away with a screwdriver or a nail. If need be, replace the spring clip if it is damaged.
4. Separate the baseplate together with the fastener guide from the piston guide.
5. Remove the piston.
6. Allow the fastener guide to slide out of the baseplate.

**NOTE** If the fastener guide does not slide of its own accord, prod it out with the piston.

#### 9.3.2 Checking the piston for wear

#### NOTE

Never use a worn or damaged piston and do not attempt to manipulate or modify the piston.

Replace the piston when:

- the piston is broken
- the piston is badly worn or chipped (e.g. a 90° segment broken away).
- the piston rings are cracked or missing.

- the piston is bent (check by rolling the piston on a smooth, flat surface).

#### 9.3.3 Checking the fastener guide for wear

Replace the fastener guide if the tubular section is damaged (e.g. bent, widened or cracked).

#### 9.3.4 Checking the spring clip for wear

Replace the spring clip if it is badly worn or bent.

#### 9.3.5 Cleaning

Clean the tool at least once a week or, respectively, immediately after each period of heavy use (after driving approx. 3,000 nails).

Use the appropriate brushes to clean the individual parts:

1. Clean the fastener guide and sleeve inside and out.
2. Clean the piston and piston rings until the parts move freely.
3. Clean the piston guide, inside and out.
4. Clean the inside of the housing.

#### 9.3.6 Lubrication

Spray the cleaned parts lightly with the Hilti lubricant spray supplied. Use only Hilti lubricant spray or a product of comparable quality.

#### 9.3.7 Assembling the tool 7

#### NOTE

Handle the small parts carefully. They could get lost.

1. Introduce the fastener guide into the baseplate.
2. Slide the piston to the end of the piston guide.
3. Place the baseplate together with the fastener guide onto the piston guide.

**NOTE** Grooves for the stop must be in line.

4. Press the spring clip into the opening of the piston guide.
5. Introduce the insert into the tool so that the groove aligns with the opening for the stop.
6. Insert the stop and pull the spring clip over it with a screwdriver or a nail.

#### 9.3.8 Checking

After carrying out care and maintenance, check that all protective and safety devices are fitted and that they function faultlessly.

#### NOTE

The tool can be checked, as follows, to determine whether it is ready to fire: Press the nose of the unloaded tool (i.e. no cartridges or fastener in the tool) firmly against a hard surface and pull the trigger. A clearly heard click from the trigger mechanism indicates that the tool was ready to fire.

## 10 Troubleshooting

### WARNING

The tool must be unloaded before taking any steps to remedy faults.

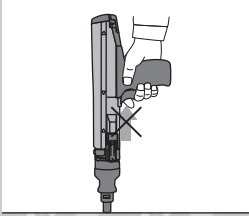
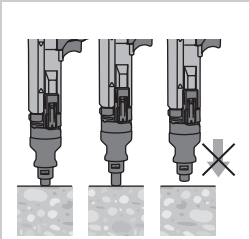
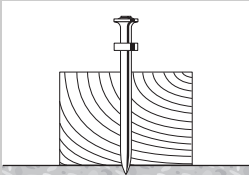
Fault	Possible cause	Remedy
Higher force required to cycle the tool.	Build-up of combustion residues.	Service the tool (see 9.3)
Higher force required to press the tool against the surface.	Build-up of combustion residues.	Service the tool (see 9.3)
Trigger resistance increases.	Build-up of combustion residues.	Service the tool (see 9.3)
The cartridge strip is difficult to remove.	Build-up of combustion residues.	Service the tool (see 9.3)
The tool cannot be fired.	The tool is not cycled. The cartridge has already been fired.	Cycle the tool (see 8.5) Remove the used cartridge and load an unused cartridge.
	The tool was not pressed fully against the working surface.	Press the tool fully against the working surface.
	Tool jams.	The tool needs to be cleaned.
	The piston is damaged.	Check the piston (see 9.3.2) and replace it if necessary.
	The tool is damaged.	If the problem persists, contact your local Hilti Center.
Misfire: the fastener is only partly driven into the base material.	The piston was in the wrong position.	Remove the cartridge strip and cycle the tool. See section: 8.5 Cycle the tool. <b>4</b>
	Bad cartridges.	Change the cartridge strip (use a different / dry package if necessary). If the problem persists: service the tool (see 9.3)

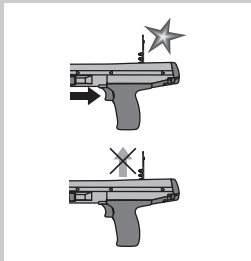
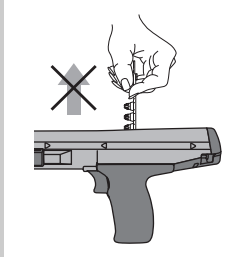
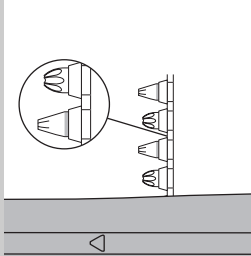
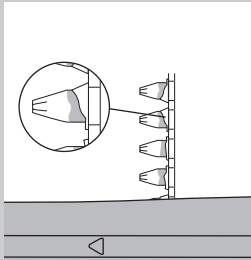
Fault	Possible cause	Remedy
<p>The cartridge strip doesn't advance.</p> 	<p>The cartridge strip is damaged.</p> <hr/> <p>The tool needs to be cleaned.</p> <hr/> <p>The tool is damaged.</p>	<p>Change the cartridge strip.</p> <hr/> <p>Clean the tool.</p> <hr/> <p>If the problem persists, contact your local Hilti Center.</p>
<p>The cartridge strip cannot be removed.</p> 	<p>The tool has overheated.</p>	<p>Allow the tool to cool down. Subsequently, carefully remove the cartridge strip from the tool.</p> <p><b>WARNING</b> Do not attempt to forcibly remove cartridges from the magazine strip or tool. If the problem persists, contact your local Hilti Center.</p>
<p>A cartridge doesn't fire.</p> 	<p>Bad cartridge.</p> <hr/> <p>The tool needs to be cleaned.</p>	<p>Pull the cartridge strip through to the next cartridge.</p> <hr/> <p>Servicing the tool <b>WARNING</b> Check that the correct cartridges are used and that they are in faultless condition. See section: 9.3 Servicing the tool If the tool cannot be disassembled, contact your local Hilti Center.</p>
<p>The cartridge strip melts.</p> 	<p>The tool is pressed against the working surface for too long before firing.</p> <hr/> <p>The fastener driving rate is too high.</p>	<p>Fire the tool sooner after pressing it against the working surface. Remove the cartridge strip.</p> <hr/> <p>Stop using the tool immediately. Remove the cartridge strip and allow the tool to cool.</p> <p><b>WARNING</b> Do not attempt to forcibly remove cartridges from the magazine strip or tool. Clean the tool and remove any loose cartridges. If the tool cannot be disassembled contact your local Hilti Center.</p>

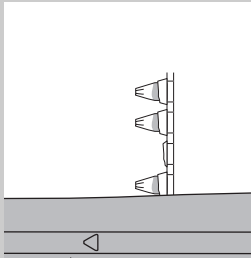
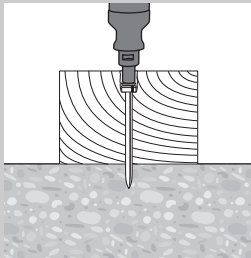
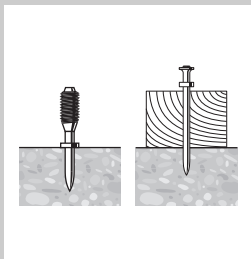
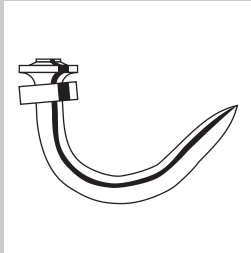

Fault	Possible cause	Remedy
<p>A cartridge detaches itself from the cartridge strip.</p> 	<p>The fastener driving rate is too high.</p>	<p>Stop using the tool immediately. Remove the cartridge strip and allow the tool to cool. <b>WARNING</b> Do not attempt to forcibly remove cartridges from the magazine strip or tool. Clean the tool and remove any loose cartridges. If the tool cannot be disassembled contact your local Hilti Center.</p>
<p>The piston gets stuck in the base material / fastener is driven too deeply.</p> 	<p>The fastener is too short.</p> <hr/> <p>The fastener has no washer.</p> <hr/> <p>Driving power is too high.</p>	<p>Use a longer fastener.</p> <hr/> <p>Use a fastener with washer for applications on wood.</p> <hr/> <p>Use a less powerful cartridge.</p>
<p>The fastener is not driven deeply enough.</p> 	<p>The fastener is too long.</p> <hr/> <p>Driving power is too low.</p>	<p>Use a shorter fastener. <b>NOTE</b> Observe the min. fastener driving depth requirements. Obtain a copy of the Fastening Technology Manual from your local Hilti Center.</p> <hr/> <p>Use a more powerful cartridge.</p>
<p>The nail bends.</p> 	<p>Hard surface (steel, concrete)</p> <hr/> <p>Hard and/or large aggregates in the concrete.</p> <hr/> <p>A rebar is located just below the concrete surface.</p>	<p>Use a more powerful cartridge. <b>NOTE</b> The DX 35 has no power regulation.</p> <hr/> <p>Use a more powerful cartridge. If necessary, use a more powerful tool and nails with a higher application limit (e.g. DX 460 with X-U nails).</p> <hr/> <p>Use a shorter nail. Use a nail with a higher application limit.</p>

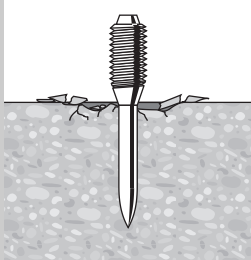
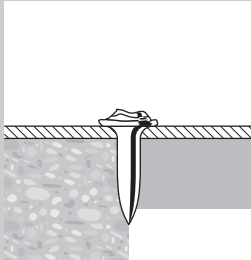
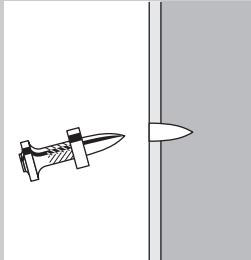
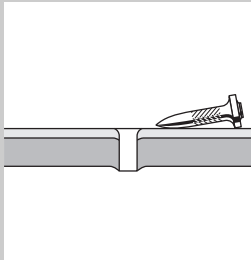
Fault	Possible cause	Remedy
<p data-bbox="82 130 236 153">Concrete spalling.</p> 	<p data-bbox="374 130 533 153">Hard/old concrete.</p> <hr/> <p data-bbox="374 197 673 239">Hard and/or large aggregates in the concrete.</p> <hr/> <p data-bbox="374 325 687 367">A rebar is located just below the concrete surface.</p>	<p data-bbox="717 130 866 153">Use a shorter nail.</p> <hr/> <p data-bbox="717 197 1034 287">Use a more powerful cartridge. If necessary, use a more powerful tool and nails with a higher application limit (e.g. DX 460 with X-U nails).</p> <hr/> <p data-bbox="717 325 1009 392">Use a shorter nail. Use a nail with a higher application limit.</p>
<p data-bbox="82 434 250 456">Damaged nail head.</p> 	<p data-bbox="374 434 586 456">Driving power is too high.</p> <hr/> <p data-bbox="374 523 684 564">Application limit exceeded (very hard material).</p> <hr/> <p data-bbox="374 635 568 657">The piston is damaged.</p>	<p data-bbox="717 434 964 456">Use a less powerful cartridge.</p> <hr/> <p data-bbox="717 523 1009 564">Use a nail with a higher application limit.</p> <hr/> <p data-bbox="717 635 874 657">Change the piston.</p>
<p data-bbox="82 730 303 772">The nail doesn't penetrate deeply enough.</p> 	<p data-bbox="374 730 580 753">Driving power is too low.</p> <hr/> <p data-bbox="374 823 684 865">Application limit exceeded (very hard material).</p> <hr/> <p data-bbox="374 935 586 957">The system is unsuitable.</p>	<p data-bbox="717 730 975 753">Use a more powerful cartridge.</p> <hr/> <p data-bbox="717 823 1009 865">Use a nail with a higher application limit.</p> <hr/> <p data-bbox="717 935 997 976">Use a more powerful system, e.g. DX 76 (PTR).</p>
<p data-bbox="82 1050 311 1091">The nail doesn't hold in the base material.</p> 	<p data-bbox="374 1050 650 1072">Thin steel base material (&lt; 4 mm)</p>	<p data-bbox="717 1050 922 1072">Use a different cartridge.</p> <p data-bbox="717 1072 1023 1114">Use a nail suitable for thin steel base material.</p>

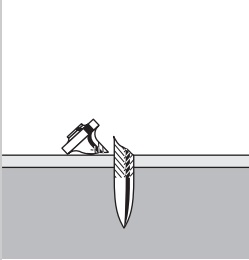
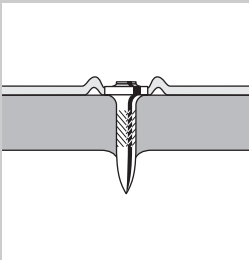
Fault	Possible cause	Remedy
<p>Nail breakage.</p> 	<p>Driving power is too low.</p> <hr/> <p>Application limit exceeded (very hard material).</p>	<p>Use a more powerful cartridge.</p> <hr/> <p>Use a shorter nail. Use a nail with a higher application limit.</p>
<p>The head of the nail punches through the material fastened (sheet metal).</p> 	<p>Driving power is too high.</p>	<p>Use a less powerful cartridge. Use a nail with a "top hat". Use a nail with a washer.</p>

## 11 Disposal



Most of the materials from which Hilti tools or appliances are manufactured can be recycled. The materials must be correctly separated before they can be recycled. In many countries, Hilti has already made arrangements for taking back old tools and appliances for recycling. Ask Hilti customer service or your Hilti representative for further information.

## 12 Manufacturer's warranty - tools

Hilti warrants that the tool supplied is free of defects in material and workmanship. This warranty is valid so long as the tool is operated and handled correctly, cleaned and serviced properly and in accordance with the Hilti Operating Instructions, and the technical system is maintained. This means that only original Hilti consumables, components and spare parts, or other products of equivalent quality, may be used in the tool.

This warranty provides the free-of-charge repair or replacement of defective parts only over the entire lifespan of the tool. Parts requiring repair or replacement as a result of normal wear and tear are not covered by this warranty.

**Additional claims are excluded, unless stringent national rules prohibit such exclusion. In particular, Hilti is not obligated for direct, indirect, incidental or consequential damages, losses or expenses in connection with, or by reason of, the use of, or inability to use the tool for any purpose. Implied warranties of merchantability or fitness for a particular purpose are specifically excluded.**

For repair or replacement, send the tool or related parts immediately upon discovery of the defect to the address of the local Hilti marketing organization provided.

This constitutes Hilti's entire obligation with regard to warranty and supersedes all prior or contemporaneous

comments and oral or written agreements concerning warranties.

### 13 EC declaration of conformity (original)

Designation:	Powder-actuated fastening tool
Type:	DX 35
Generation:	01
Year of design:	1976

We declare, on our sole responsibility, that this product complies with the following directives and standards: 2006/42/EC, 2011/65/EU.

Hilti Corporation, Feldkircherstrasse 100,  
FL-9494 Schaan



**Norbert Wohlwend**  
Head of Quality & Processes Management  
BU Direct Fastening  
04/2013



**Tassilo Deinzer**  
Head BU Measuring Systems

BU Measuring Systems  
04/2013

**Technical documentation filed at:**

Hilti Entwicklungsgesellschaft mbH  
Zulassung Elektrowerkzeuge  
Hiltistrasse 6  
86916 Kaufering  
Deutschland

en

### 14 Confirmation of CIP testing

The following applies to C.I.P. member states outside the EU and EFTA judicial area: The Hilti DX 35 has been system and type tested. As a result, the tool bears the rectangular PTB approval mark showing approval number S 806. Hilti thus guarantees compliance with the ap-

proved type. Unacceptable defects or deficiencies, etc. determined during use of the tool must be reported to the person responsible at the approval authority (PTB) and to the Office of the Permanent International Commission (C.I.P.).

### 15 Health and safety of the operator

#### 15.1 Noise information

**Powder-actuated fastening tool**

Type	DX 35
Model	Series
Caliber	6.3/10 yellow
Application	Fastening 1 mm sheet steel to concrete (C40) with the X-U22 P8 The tool has no power regulation feature.

**Declared measured values of noise characteristics according to 2006/42/EC Machinery Directive in conjunction with DIN EN 15895**

Noise (power) level, $L_{WA, 1s}^1$	113 dB (A)
Emission noise-pressure level in the work station, $L_{pA, 1s}^2$	109 dB (A)
Peak sound pressure emission level, $L_{pC, peak}^3$	142 dB (C)

<sup>1</sup> ± 2 dB (A)  
<sup>2</sup> ± 2 dB (A)  
<sup>3</sup> ± 2 dB (C)

**Operation and set-up conditions:** Set-up and operation of the pin driver in accordance with E DIN EN 15895-1 in the semi-anechoic test room of Müller-BBM GmbH. The ambient conditions in the test room conform to DIN EN ISO 3745.

**Testing procedure:** Enveloping surface method in anechoic room on reflective surface area in accordance with E DIN EN 15895, DIN EN ISO 3745 and DIN EN ISO 11201.

NOTE The noise emissions measured and the associated measurement uncertainty represent the upper limit for the noise values to be expected during the measurements.

Variations in operating conditions may cause deviations from these emission values.

en

## 15.2 Vibration

Total vibration in accordance with 2006/42/EC does not exceed 2.5 m/s<sup>2</sup>.

Further information about user health and safety can be found at [www.hilti.com/hse](http://www.hilti.com/hse).



Hilti Corporation

LI-9494 Schaan

Tel.: +423 / 234 21 11

Fax: +423 / 234 29 65

[www.hilti.com](http://www.hilti.com)

Hilti = registered trademark of Hilti Corp., Schaan

W 1037 | 0813 | 0-Pos. 3 | 1

Printed in China © 2013

Right of technical and programme changes reserved S. E. & O.

2143 / A3



2143