

HILTI

POS 15/18

Operating instructions

en



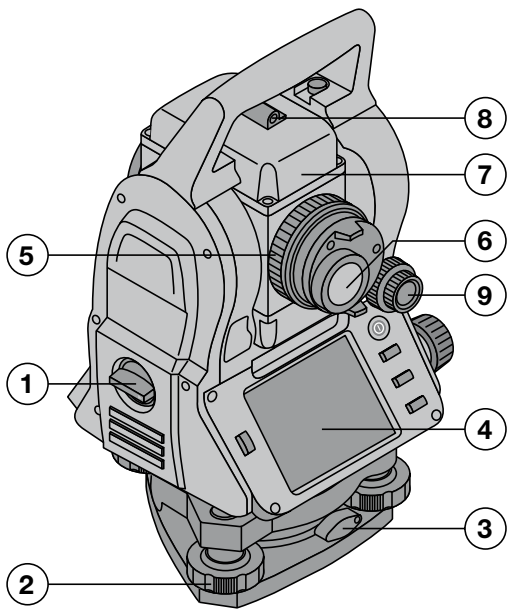

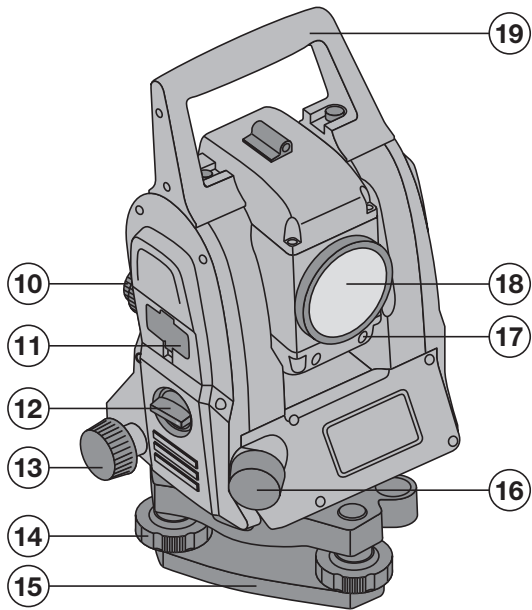

3

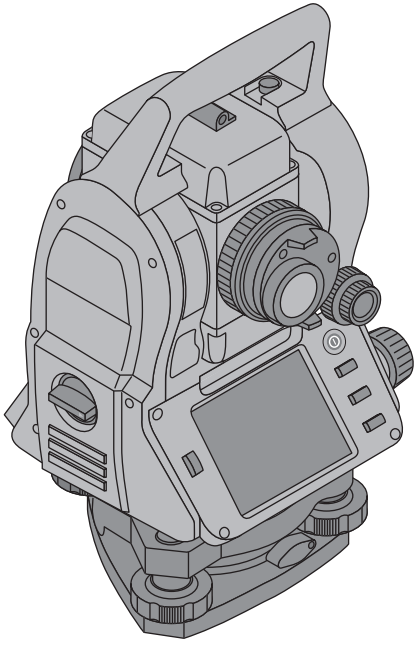

4

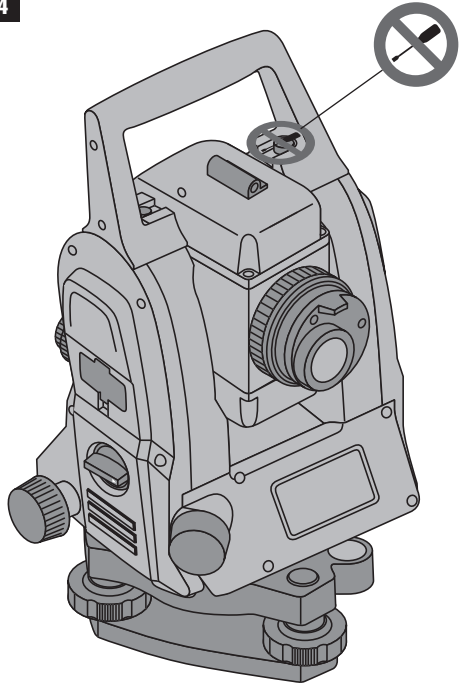

5

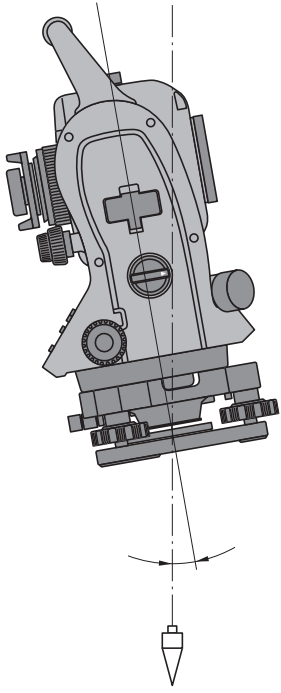

6

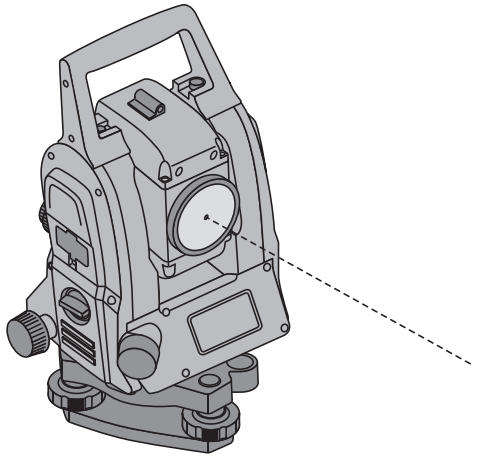

7

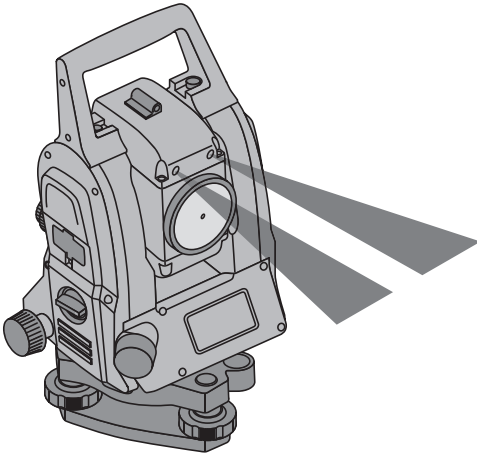

8

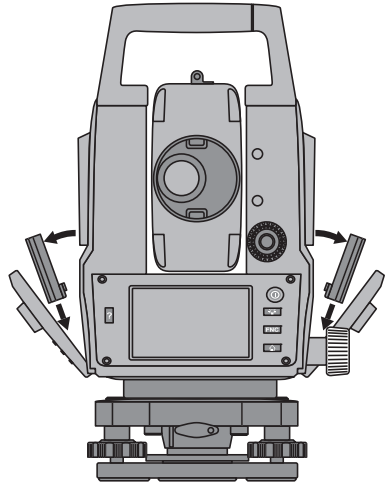

9

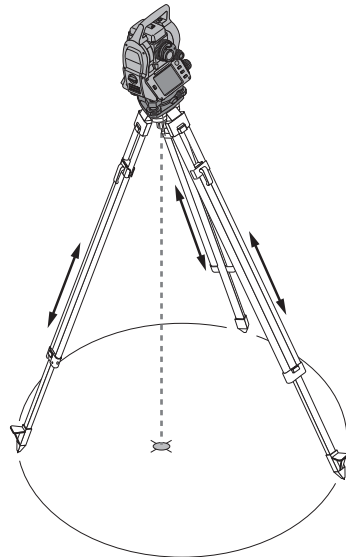
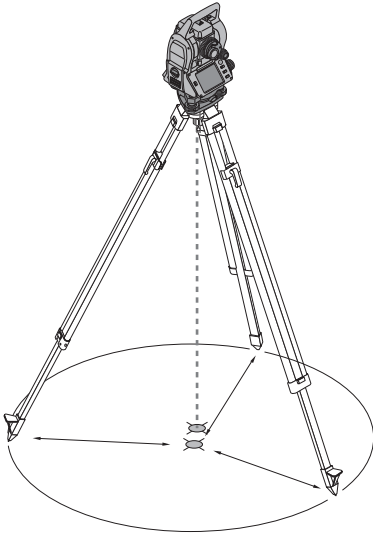

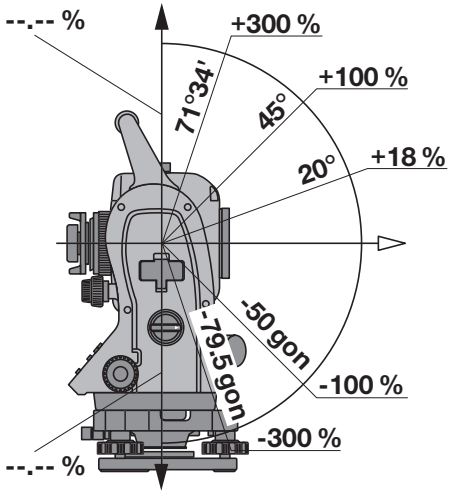

POS 15/18 total station

It is essential that the operating instructions are read before the tool is operated for the first time.

Always keep these operating instructions together with the tool.

Ensure that the operating instructions are with the tool when it is given to other persons.

1 These numbers refer to the illustrations. You can find the illustrations at the beginning of the operating instructions.
In these operating instructions, the designation “the tool” always refers to the POS 15 or POS 18.

Rear casing section **1**

- ① Left battery compartment with cover retaining screw

- ② Tribrach footscrew
- ③ Tribrach lock
- ④ Touch screen control panel
- ⑤ Focussing knob
- ⑥ Eyepiece
- ⑦ Telescope with laser distancer
- ⑧ Alignment sight (sighting aid)
- ⑨ Vertical drive

Front casing section **2**

- ⑩ Vertical drive
- ⑪ USB interface connectors (small and large)
- ⑫ Right battery compartment with cover retaining screw
- ⑬ Horizontal drive
- ⑭ Tribrach footscrew
- ⑮ Tribrach
- ⑯ Laser plummet
- ⑰ Guide light
- ⑱ Objective lens
- ⑲ Carrying handle

Contents

1	General information	5
1.1	Safety notices and their meaning	5
1.2	Explanation of the pictograms and other information	5
2	Description	6
2.1	Use of the product as directed	6
2.2	Description of the tool	6
2.3	Items supplied	6
3	Technical data	7
4	Safety instructions	8
4.1	Basic information concerning safety	8
4.2	Misuse	8
4.3	Proper organization of the work area	9
4.4	Electrical safety	9
4.5	Electromagnetic compatibility	9
4.5.1	Laser classification for Laser Class 2 products	9
4.5.2	Laser classification for Laser Class 3R products	9
4.6	Careful use of battery-powered tools	9
4.7	General safety rules	10
4.8	Transport	10
5	Description of the system	10
5.1	General terms	10
5.1.1	Coordinates	10
5.1.2	Control lines	11

5.1.3	Technical terms	11
5.1.4	Telescope positions 3 4	12
5.1.5	Terms and their description	12
5.1.6	Abbreviations and their meaning	14
5.2	Angle measurement system	14
5.2.1	Measuring principle	14
5.2.2	Dual-axis compensator 5	15
5.3	Distance measurement	15
5.3.1	Distance measurement 6	15
5.3.2	Targets	16
5.3.3	Reflector rod	16
5.4	Height measurement	17
5.4.1	Height measurement	17
5.5	Guide light	18
5.5.1	Guide light 7	18
5.6	Laser pointer 6	18
5.7	Data points	18
5.7.1	Selecting points	18
6	First steps	19
6.1	Batteries	19
6.2	Charging the battery	19
6.3	Inserting and changing the battery 8	19
6.4	Checking functions	19
6.5	Control panel	20
6.5.1	Function buttons	20
6.5.2	Size of the touch screen	20
6.5.3	Division of the touch screen	20
6.5.4	Touch screen – numerical keyboard	21
6.5.5	Touch screen – alphanumeric keyboard	21
6.5.6	Touch screen – general operating controls	22
6.5.7	Laser pointer status indicator	22
6.5.8	Battery condition indicators	22
6.6	Further information and operating instructions	22
6.7	Switching on / off	23
6.7.1	Switching on	23
6.7.2	Switching off	23
6.8	Setting up the tool	23
6.8.1	Setting up over a mark on the floor or ground using the laser plummet	23
6.8.2	Setting up the tool 9	24
6.8.3	Setting up over a pipe using the laser plummet	24
6.9	Dynamic exchange of data with design applications (optional)	25
6.9.1	Installation of Hilti PROFIS Connect	25
6.9.2	Starting Hilti PROFIS Connect for the first time	25
6.9.3	Starting data exchange with a design application	25
7	System settings	27
7.1	Configuration	27
7.2	Settings	27
7.3	Calibrating the display	27
7.4	Time and date	27
7.5	In-the-field calibration	27
7.6	Hilti Repair Service	28
7.7	Prism settings	28

7.8	Settings for EDM and standard target	28
7.9	System information (I)	28
8	Function menu (FNC)	29
8.1	Guide light	29
8.2	Compensator	30
8.3	Laser pointer	30
8.4	Correction of atmospheric influences	30
8.5	EDM settings	31
8.6	Display illumination	31
8.7	Bubble level (compensator)	31
8.8	Help	32
9	Functions required for various applications	32
9.1	Projects	32
9.1.1	Showing the active project	32
9.1.2	Selecting a project	32
9.1.3	Creating a new project	32
9.1.4	Project information	32
9.2	Setting a station and orientation	32
9.2.1	Overview	32
9.2.2	Setting the station over a point	33
9.2.3	Setting a station “anywhere”	36
9.2.4	Station with building control line	39
9.2.5	Set station	42
9.3	Setting up the tool with height	42
10	Applications	43
10.1	Horizontal layout (Horz. layout)	43
10.1.1	Principle of the layout procedure	43
10.1.2	Setting out (layout) with prism	43
10.1.3	Layout with visible laser (laser pointer)	46
10.2	Measure and record	49
10.2.1	The principle of “Measure and record”	49
10.2.2	Procedure for application “Measure and record”	50
10.3	Reference line	51
10.3.1	Principle of the reference line	52
10.3.2	Reference line with prism	53
10.3.3	Reference line with visible laser (laser pointer)	55
10.3.4	Saving layout data	55
10.4	As-built	56
10.4.1	The principle of “As-built”	56
10.4.2	As-built with prism	56
10.5	Exchanging data with a PC for “Layout” and “Measure & Record”	58
10.5.1	Procedure with the PROFIS Connect application	58
10.6	Vertical layout (Vert. layout)	59
10.6.1	The vertical layout principle	59
10.6.2	Vertical layout with building control lines	60
10.6.3	Vertical layout with coordinates	63
10.7	CoGo (Coordinate Geometry)	65
10.7.1	Overview	65
10.7.2	Inverse	66
10.7.3	Offset	68
10.7.4	Intersection	70

10.7.5	Angle	71
10.7.6	Calculate area	72
10.8	Missing line	73
10.8.1	The principle of "Missing line"	73
10.8.2	Procedure for "missing line" application	74
10.9	Area measurement	76
10.9.1	The principle of area measurement	76
10.9.2	Procedure for area measurement application	76
10.9.3	Saving data for area measurement	77
10.10	Theodolite	77
10.10.1	Zeroing the circle reading	77
10.10.2	Setting the horizontal circle display	78
10.10.3	Entering a circle reading manually	79
10.10.4	Inclination indicator 10	79
10.11	Indirect height measurement	80
10.11.1	The principle of indirect height measurement	80
10.11.2	Indirect height measurement	81
10.12	Vertical alignment	81
10.12.1	The principle of "Vertical alignment"	81
10.13	Plan & Points	83
10.13.1	Starting an application	83
10.13.2	Overview	84
10.13.3	Extracting / creating points	85
10.13.4	Drawing	86
10.13.5	General settings	86
10.14	Activating data exchange with design applications	87
10.14.1	Procedure with the PROFIS Connect application	87
11	Data and data handling	88
11.1	Introduction	88
11.2	Point data	88
11.2.1	Points in the form of measured points	88
11.2.2	Points in the form of coordinate points	88
11.2.3	Points with graphical elements	89
11.3	Generation of point data	89
11.3.1	With the total station	89
11.3.2	With Hilti PROFIS Layout	89
11.3.3	With Hilti Point Creator	89
11.4	Data memory	89
11.4.1	Total station internal memory	89
11.4.2	USB memory	90
12	Total station data manager	90
12.1	Overview	90
12.2	Procedure for "Data manager" application	90
12.2.1	Import / export manager	91
12.2.2	Project manager	92
12.2.3	Point manager	93
12.2.4	Graphic manager	94
13	Exchanging data with a PC	94
13.1	Introduction	94
13.2	HILTI PROFIS Layout	95
13.2.1	Data types	95
13.2.2	Hilti PROFIS Layout data output (export)	95

13.2.3	Hilti PROFIS Layout data input (import)	96
13.2.4	Review of Hilti Point Creator functions	96
13.3	Overview of functions provided by the PROFIS Connect application	97
14	RS 232 interface for data transfer	98
15	Calibration and adjustment	98
15.1	In-the-field calibration	98
15.2	Checking alignment of the laser point with the cross hairs	99
15.3	Procedure for the calibration application	99
15.3.1	Calibrating the target axis error and VA collimation error	100
15.4	Hilti Repair Service	101
16	Care and maintenance	102
16.1	Cleaning and drying	102
16.2	Storage	102
16.3	Transport	102
17	Disposal.....	102
18	Manufacturer's warranty.....	103
19	FCC statement (applicable in US) / IC statement (applicable in Canada).....	103
20	EC declaration of conformity (original).....	103

1 General information

1.1 Safety notices and their meaning

DANGER
 Draws attention to imminent danger that will lead to serious bodily injury or fatality.

WARNING
 Draws attention to a potentially dangerous situation that could lead to serious personal injury or fatality.

CAUTION
 Draws attention to a potentially dangerous situation that could lead to slight personal injury or damage to the equipment or other property.

NOTE
 Draws attention to an instruction or other useful information.

1.2 Explanation of the pictograms and other information

Symbols

			
Read the operating instructions before use.	General warning	Return materials for recycling	Do not look into the beam.
			
Do not turn the screw			

Symbol for Laser Class II / Class 2



Laser class II
according to
CFR 21, § 1040
(FDA)

Laser Class
2 in
accordance
with IEC/EN
60825-1:2007

Symbol for Laser Class III / Class 3



Laser class II
according to
CFR 21, § 1040 (FDA)

Do not look
into the
beam with
the naked
eye or with
optical
instruments.

Laser exit aperture



Laser exit aperture

Location of identification data on the tool

The type designation and serial number can be found on the type identification plate on the tool. Make a note of this data in your operating instructions and always refer to it when making an enquiry to your Hilti representative or service department.

Type:

Generation: 01

Serial no.:

2 Description

2.1 Use of the product as directed

The tool is designed for measuring distances and directions, calculating target positions in 3 dimensions and the values derived from these positions and for laying out points using given coordinates or values relative to a control line.

To avoid the risk of injury, use only genuine Hilti accessories and insert tools.

Observe the information printed in the operating instructions concerning operation, care and maintenance.

Take the influences of the surrounding area into account. Do not use the appliance where there is a risk of fire or explosion.

Modification of the tool is not permissible.

2.2 Description of the tool

The POS 15/18 total station can be used to determine the exact position of objects or points. The tool is equipped with horizontal and vertical circles with digital graduation, two electronic levels (compensators), a coaxial laser distance incorporated in the telescope and an electronic processor system for calculating and saving data.

Hilti PROFIS Layout, a PC application provided by Hilti, can be used to transfer data in both directions between

the total station and a PC, for data processing and for exporting data to other systems.

2.3 Items supplied

- 1 Total station
- 1 AC adapter incl. charging cable for chargers
- 1 Charger
- 2 3.8 V 5200 mAh Li-ion battery
- 1 Reflector rod
- 1 POW 10 adjusting key
- 2 Laser warning plate
- 1 Manufacturer's certificate
- 1 Operating instructions
- 1 Hilti toolbox
- 1 Optional: Hilti PROFIS Layout (PC software on CD-ROM)
- 1 Optional: Copy protection dongle for PC software
- 1 Optional: USB data cable

NOTE

Genuine Hilti products and accessories can be found at your Hilti Center or online at www.hilti.com.

3 Technical data

Right of technical changes reserved.

NOTE

The only difference between the two tools is their angle measurement accuracy.

Telescope

Telescope magnification	30x
Shortest target distance	1.5 m (4.9 ft)
Telescope angle of view	1° 20': 2.3 m / 100 m (7.0 ft / 300 ft)
Objective lens aperture	45 mm (1.8")

Compensator

Type	Dual-axis, liquid
Working range	±3'
Accuracy	2"

Angle measurement

POS 15 accuracy (DIN 18723)	5"
POS 18 accuracy (DIN 18723)	3"
Angle reading system	Diametral

Distance measurement

Range	340 m (1000 ft) Kodak 90% gray
Accuracy	±3 mm + 2 ppm (0.01 ft + 2 ppm)
Laser class	Class 3R, visible, 630-680 nm, $P_o < 4.75$ mW, $f = 320$ -400 MHz (EN 60825-1/ IEC 60825-1); Class III (CFR 21 § 1040 (FDA))

Guide light

Aperture angle	1.4°
Typical range	70 m (230 ft)

Laser plummet

Accuracy	1.5 mm at 1.5 m (1/16 at 3 ft)
Laser class	Class 2, visible, 635 nm, $P_o < 1$ mW (EN 60825-1/ IEC 60825-1); Class II (CFR 21 §1040 (FDA))

Data memory

Memory size (data blocks)	10,000
Data transfer interfaces	Host and client, 2 x USB

Display

Type	Color display (touch screen), 320 x 240 pixels
Illumination	5 levels
Contrast	Day / night mode selectable

Protection class

Protection class	IP 56
------------------	-------

Horizontal drive

Type	Continuous
------	------------

Tripod thread

Tribrach thread	5/8"
-----------------	------

en

POA 80 battery

Type	Li-ion
Rated voltage	3.8 V
Battery capacity	5,200 mAh
Charging time	4 h
Battery life (with distance / angle measurement every 30 seconds)	16 h
Weight	0.1 kg (0.2 lbs)
Dimensions	67 mm x 39 mm x 25 mm (2.6" x 1.5" x 1.0")

POA 81 AC adapter and POA 82 charger

AC supply	100...240 V
AC frequency	47...63 Hz
Rated current input	4 A
Rated voltage	5 V
Weight (POA 81 AC adapter)	0.25 kg (0.6 lbs)
Weight (POA 82 charger)	0.06 kg (0.1 lbs)
Dimensions (POA 81 AC adapter)	108 mm x 65 mm x 40 mm (4.3" x 2.6" x 0.1")
Dimensions (POA 82 charger)	100 mm x 57 mm x 37 mm (4.0" x 2.2" x 1.5")

Temperature

Operating temperature range	-20... +50°C (-4°F to +122°F)
Storage temperature range	-30... +70°C (-22°F to +158°F)

Dimensions and weights

Dimensions	149 mm x 145 mm x 306 mm (5.9" x 5.7" x 12")
Weight	4.0 kg (8.8 lbs)

4 Safety instructions

4.1 Basic information concerning safety

In addition to the information relevant to safety given in each of the sections of these operating instructions, the following points must be strictly observed at all times.

4.2 Misuse

The tool and its ancillary equipment may present hazards when used incorrectly by untrained personnel or when used not as directed.

- a) **Never use the tool without having received the appropriate instruction on its use or without having read these operating instructions.**

- b) **Never point the tool or its accessories toward yourself or other persons.**
- c) The connecting cable between the PC and the POS 15/18 must be clearly visible and positioned so that it presents no hazard.
- d) **Do not render safety devices ineffective and do not remove information and warning notices.**
- e) When switching distance measurement from prism measurement to reflectorless measurement, make sure that you do not look at the objective lens of the tool.
- f) Have the tool repaired only at a Hilti Service Center. **Failure to follow the correct procedures when opening the tool may cause emission of laser radiation in excess of class 3R.**

- g) Modification of the power tool or tampering with its parts is not permissible.
- h) The grip is designed to have a certain amount of play at one side. This is not a fault. It serves to protect the alidade. Tightening the screws on the grip may cause damage to the thread, making costly repairs necessary. **Do not tighten any screws on the grip!**
- i) To avoid the risk of injury, use only genuine Hilti accessories and additional equipment.
- j) Use only clean, soft cloths for cleaning. If necessary, they may be moistened with a little alcohol.
- k) **Keep laser tools out of reach of children.**
- l) Measurements taken to plastic foam surfaces, e.g. polystyrene foam, to snow or to highly reflective surfaces, may result in incorrect readings.
- m) Measurements taken to surfaces with low reflectivity in highly reflective surroundings may be inaccurate.
- n) Measurements taken through panes of glass or other objects may be inaccurate.
- o) The measurement may be incorrect if the conditions under which the measurement is taken change rapidly, e.g. due to people walking through the path of the laser beam.
- p) Do not point the tool toward the sun or other powerful light sources.
- q) Do not use the tool as a level.
- r) Check the tool before taking important measurements or after it has been dropped or subjected to mechanical effects such as impact or vibration.

4.3 Proper organization of the work area

- a) Secure the area in which you are working and take care to avoid directing the beam toward other persons or toward yourself when setting up the tool.
- b) Use the tool only within the defined application limits, i.e. do not take readings from mirrors, stainless steel or polished stone, etc.
- c) Observe the accident prevention regulations applicable in your country.

4.4 Electrical safety

- a) **Check the condition of the extension cord and replace it if damage is found. Do not touch the AC adapter if the extension cord or AC adapter are damaged while working. Disconnect the supply cord plug from the power outlet.** Damaged supply cords or extension cords present a risk of electric shock.
- b) Do not touch the supply cord or extension cord if damaged while working. Disconnect the supply cord plug from the power outlet. Damaged supply cords or extension cords present a risk of electric shock.

4.5 Electromagnetic compatibility

Although the tool complies with the strict requirements of the applicable directives, Hilti cannot entirely rule out the possibility of the tool

- causing interference to other tools (e.g. aircraft navigation equipment) or being subject to

- interference caused by powerful electromagnetic radiation, leading to incorrect operation.

Check the accuracy of the tool by taking measurements by other means when working under such conditions or if you are unsure.

4.5.1 Laser classification for Laser Class 2 products

The laser plummet of the tool complies with Laser Class 2 based on the IEC/EN 60825-1:2007 standard and Class II based on CFR 21 § 1040 (Laser Notice 50). In the event of direct eye contact with the laser beam, close your eyes and move your head out of the path of the beam. Do not look directly into the light source. Do not direct the laser beam toward persons.

4.5.2 Laser classification for Laser Class 3R products

- a) This device complies with Laser Class 3R in accordance with IEC/EN 60825-1:2007 and Class IIIa in accordance with CFR 21 § 1040 (Laser Notice 50). In the event of direct eye contact with the laser beam, close your eyes and move your head out of the path of the beam. Do not look directly into the light source. Do not direct the laser beam toward persons.
- b) Tools of the laser class 3R and class IIIa should be operated by trained personnel only.
- c) The area in which the tool is in use must be marked with laser warning signs.
- d) Precautions must be taken to ensure that the laser beam does not unintentionally strike highly reflective surfaces.
- e) Precautions must be taken to ensure that persons do not stare directly into the beam.
- f) The laser beam must not be allowed to project beyond the controlled area.
- g) When not in use, laser tools should be stored in an area to which unauthorized persons have no access.

4.6 Careful use of battery-powered tools

- a) **Do not expose batteries to high temperatures and keep them away from fire.** This presents a risk of explosion.
- b) Under abusive conditions, liquid may leak from the battery. **Avoid contact. If contact accidentally occurs, flush with water. In the event of the liquid coming into contact with the eyes, rinse the eyes with plenty of water and consult a doctor.** Liquid ejected from the battery may cause irritation or burns.
- c) **Do not disassemble, squash or incinerate batteries and do not subject them to temperatures over 75°C.** This presents a risk of fire, explosion or injury through contact with caustic substances.
- d) **Do not charge or continue to use damaged batteries (e.g. batteries with cracks, broken parts, bent or pushed-in and/or pulled-out contacts).**
- e) **Paper clips, coins, keys, nails, screws and other small metal objects that could short-circuit the**

- electrical contacts must be kept away from batteries that are not in use and away from battery chargers. Short-circuiting the contacts on a battery or charger may cause burning injuries or start a fire.
- f) **Recharge only with the charger specified by the manufacturer.** A charger that is suitable for a certain type of battery may present a risk of fire when used with other types of battery.
 - g) **Use only batteries of the type approved for use with the applicable tool.** Use of other batteries or use of the batteries for purposes for which they are not intended presents a risk of fire and explosion.

4.7 General safety rules

- a) **Before taking measurements, the user must make sure that the instruments and equipment used meet the requirements of the task.**
 - b) **Do not operate the tool in explosive atmospheres, such as in the presence of flammable liquids, gases or dust.** tools and appliances create sparks which may ignite the dust or fumes.
 - c) **Stay alert, watch what you are doing and use common sense when operating the machine. Don't use the machine when you are tired or under the influence of drugs, alcohol or medication.** A moment of inattention while operating machines may result in serious personal injury.
 - d) **When a tripod or wall mount is used, check that the tool is correctly and permanently mounted and that the tripod is standing securely on solid ground.**
 - e) **Maintain the machine carefully. Check for misalignment or binding of moving parts, breakage of parts and any other condition that may affect the machine's operation. If damaged, have the machine repaired before use.** Poor maintenance is the cause of many accidents.
- f) **Although the tool is protected to prevent entry of dampness, it should be wiped dry each time before being put away in its transport container.**
 - g) **Check the tool for damage before use.** If the tool is found to be damaged, have it repaired at a Hilti service center.
 - h) **Operating and storage temperatures must be observed.**
 - i) **Check the accuracy of the tool after it has been dropped or subjected to other mechanical stresses.**
 - j) **When the tool is brought into a warm environment from very cold conditions, or vice-versa, allow it to become acclimatized before use.**
 - k) **Keep the laser exit aperture clean to avoid measurement errors.**
 - l) **Although the tool is designed for the tough conditions of jobsite use, as with other optical and electronic instruments (e.g. binoculars, spectacles, cameras) it should be treated with care.**
 - m) **As a precaution, check the previous settings or any adjustments you may have made.**
 - n) **View the tool at an angle when setting it up with the aid of the circular bubble level.**
 - o) **Secure the battery compartment cover carefully in order to ensure that the battery cannot fall out and that no contact can occur which would result in the tool being switched off inadvertently possibly resulting in loss of data.**

4.8 Transport

Observe the special guidelines applicable to the transport, storage and use of Li-ion batteries.

The batteries must be insulated or removed from the tool before the tool is shipped or sent by mail. Leaking batteries may damage the tool.

To avoid pollution of the environment, the tool and the batteries must be disposed of in accordance with the currently applicable national regulations.

Consult the manufacturer if you are unsure of how to proceed.

5 Description of the system

5.1 General terms

5.1.1 Coordinates

On some construction sites, instead of or in combination with control lines, additional points are marked out and their positions described by coordinates.

The coordinates used are generally based on the national coordinate system which is also usually taken as a basis for maps of the country.

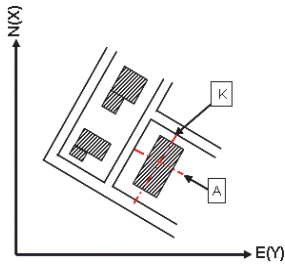

5.1.2 Control lines

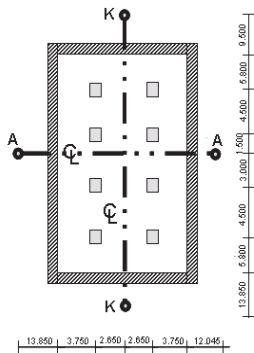

Height marks and control lines are generally marked out on and around the building plot by a surveyor before construction begins.

Two ends are marked on the ground for each control line.

These marks are used to position the individual components of the building or structure. Large buildings require a number of control lines.

5.1.3 Technical terms

Tool axes

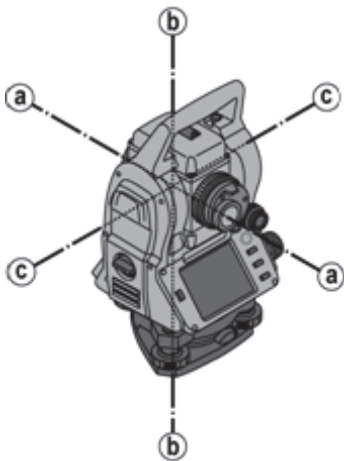

- a Sighting axis

- b Vertical axis

- c Trunnion (tilt axis)

Horizontal circle / horizontal angle

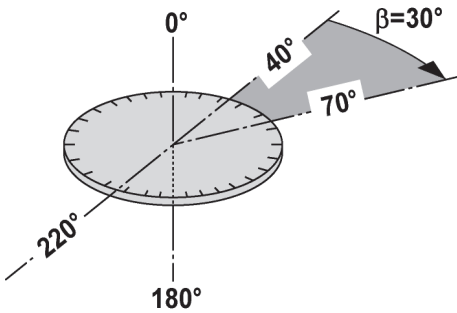

The included angle of $70^\circ - 40^\circ = 30^\circ$ can be calculated from the horizontal circle readings of 70° to one target and 30° to the other target.

Vertical circle / vertical angle

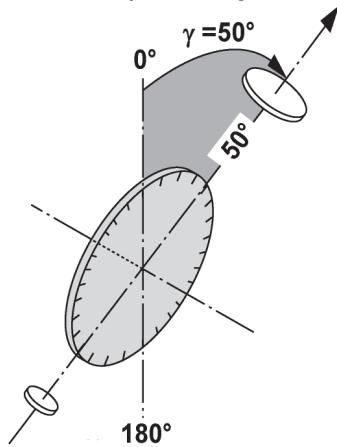

As the vertical circle is aligned at 0° to the direction of gravity or at 0° to horizontal, angles are determined relative to the direction of gravity, so to speak.

Using these values, the horizontal distance and vertical distance are calculated from the measured slope distance.

5.1.4 Telescope positions 3 4

The term “telescope position” is used to ensure that readings from the horizontal circle can be correctly assigned to the vertical angle, i.e. the position of the telescope relative to the control panel determines in which “position” the measurements have been taken.

When the display and the eyepiece are immediately in front of you, then the tool is in telescope position 1. **3**

When the display and the objective lens are immediately in front of you, then the tool is in telescope position 2. **4**

5.1.5 Terms and their description

Target axis	The line through the cross hairs and center of the objective lens (telescope axis).
Trunnion	The telescope pivot (tilt) axis.
Vertical axis	The pivot axis of the entire tool.
Zenith	The zenith is the point that lies in the direction of gravity, but in the opposite, upward direction.

Horizon	The horizon is the direction perpendicular to the direction of gravity – generally known as horizontal.
Nadir	Nadir is the name given to the downward direction in which gravity acts.
Vertical circle	The vertical circle is the circle of angles described by the telescope when it is tilted upwards or downwards.
Vertical direction	A reading taken from the vertical circle is known as the vertical direction.
Vertical angle (VA)	A vertical angle is a reading from the vertical circle. The vertical circle is usually aligned with the direction of gravity with the aid of the compensator, with the zero point at the zenith.
Elevation angle	An elevation angle of zero refers to the horizon (horizontal plane). Positive angles are above horizontal (upwards) and negative angles are below horizontal (downwards).
Horizontal circle	The horizontal circle is the complete circle of angles described by the tool when it is rotated.
Horizontal direction	A reading taken from the horizontal circle is known as the horizontal direction.
Horizontal angle (HA)	A horizontal angle is the difference between two readings from the horizontal circle. However, a reading from one of the circles is also often described as an angle.
Slope distance (SD)	Distance from the center of the telescope to the point at which the laser beam strikes the target surface
Horizontal distance (HD)	The horizontal distance derived from the measured slope distance.
Alidade	The rotatable center part of the total station is known as the alidade. This part usually carries the control panel, bubble levels for leveling and, inside, the horizontal circle.
Tribrach	The tool stands on the tribrach which, for example, can be mounted on a tripod. The tribrach has three points of contact which can be adjusted vertically by adjusting screws.
Tool standpoint	This is the point at which the tool is set up - usually over a point marked on the ground.
Station height (Stat H)	The height of the point on the ground at the tool station (above a reference height).
Instrument height (HI)	The height from the point on the ground or floor to the center of the telescope.
Reflector height (HR)	The distance from the center of the reflector to the tip of the reflector rod.
Orientation (backsight) point	The target point used in conjunction with the tool station to determine the horizontal reference direction for the horizontal angle measurement.
EDM	E lectronic D istance M easurer (laser distancer / range meter).
East (E)	In a typical surveying coordinate system this value refers to the east-west direction.
North (N)	In a typical surveying coordinate system this value refers to the north-south direction.
Line (L)	This is the term used to describe a longitudinal measurement along a building control line or other reference line.
Offset (O)	This is the term used for a distance at right angles to a control line or other reference line.
Height (H)	Many values are referred to as heights. A height is a vertical distance from a reference point or reference surface.

5.1.6 Abbreviations and their meaning

HA	Horizontal angle
VA	Vertical angle
dHA	Delta horizontal angle
dVA	Delta vertical angle
SD	Slope distance
HD	Horizontal distance
dHD	Delta horizontal distance
HI	Instrument height
HR	Reflector height
BM height	Benchmark height
Stat H	Station height
h	Height
E	East
N	North
O	Offset
l	Line value
dH	Delta height
dE	Delta east
dN	Delta north
dOffs	Delta offset horz
dL	Delta line

5.2 Angle measurement system

5.2.1 Measuring principle

The tool calculates the angle in each case from two circle readings.

For the purpose of distance measurement, pulses transmitted along a visible laser beam at a certain wavelength are reflected from the object to which the measurement is being taken.

Distances can be determined from the values obtained from these pulses.

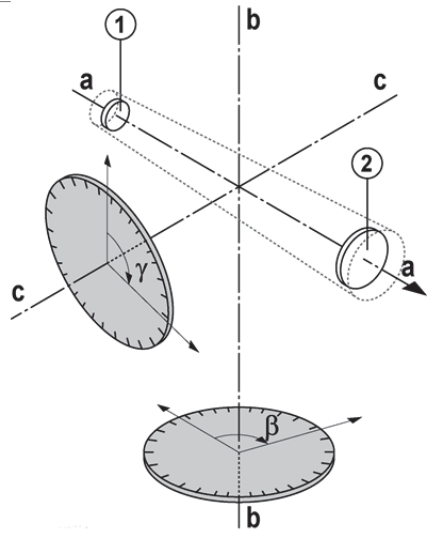
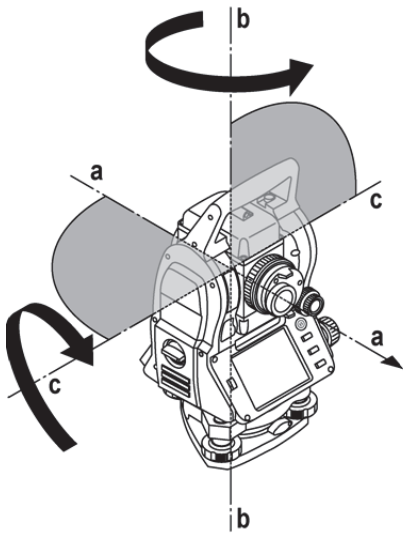

Tool inclination is determined with the aid of electronic levels (compensators), circle readings are corrected accordingly and the height difference is also calculated from the measured slope distance and horizontal distance.

The built-in microprocessor system allows conversion of all distance units between the metric and imperial systems (feet, yards, inches, etc.) and digital circle graduation allows various angle units to be shown, e.g. 360° sexagesimal graduation (° ' ") or gon (g) in which the full circle consists of 400g graduations.

5.2.2 Dual-axis compensator 5

A compensator is, in principle, an electronic leveling system that determines exactly the remaining inclination ("off level") of the axes of the total station after it has been set up.

The dual-axis compensator determines this remaining inclination of the tool with great accuracy in the line and offset axes.

All calculations are then corrected automatically to ensure that this remaining inclination has no influence on angle measurements.

5.3 Distance measurement

5.3.1 Distance measurement 6

NOTE

Distance measurement, accuracy and the time required to take a measurement depend on the angle of the laser beam to the target, the material from which the target is made, the reflectivity of the target and the ambient conditions.

Distance measurement is by way of a visible laser beam emitted through the center of the objective lens, i.e the laser distancer is coaxial.

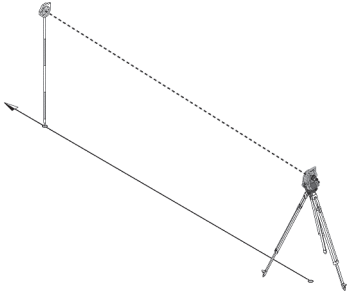

The laser beam takes measurements to “normal” surfaces without need for a special reflector. “Normal” surfaces are considered to be those that are not highly reflective. These surfaces may have a rough texture. Range depends on the reflectivity of the target surface, i.e. only slightly reflective surfaces such as those with a blue, red or green color may reduce the effective range. The tool is supplied complete with a reflector rod to which an adhesive reflective foil is attached. Taking readings from this reflector ensures reliable distance measurements even at long range. The reflector rod also allows distance measurements to be taken to points marked on the ground.

NOTE

Check at regular intervals to ensure that the visible laser distancer beam is correctly adjusted and in line with the sighting axis. Send the tool to your nearest Hilti Service Center if adjustment is found necessary or if you are unsure.

5.3.2 Targets

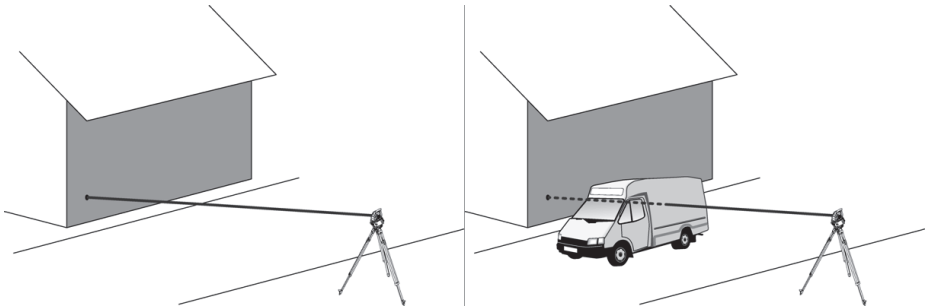

The measuring beam can be used to measure the distance to any stationary target.

NOTE

Other objects must not move through the measuring beam while distance measurement is taking place. Otherwise, the distance to the other object may be measured instead of the distance to the desired target.

5.3.3 Reflector rod

The POA 50 (metric) reflector rod (consisting of four sections (each with a length of 300 mm), the rod point (length 50 mm) and the reflector plate (height 100 mm or, respectively, 50 mm to the middle)) is used to take readings from points on the ground.

The POA 51 (imperial) reflector rod (consisting of four sections (each with a length of 12"), the rod point (length 2.03") and the reflector plate (height 3.93" or, respectively, 1.97" to the middle)) is used to take readings from points on the ground.

The reflector rod can be held perpendicular to the ground or floor with the aid of the built-in bubble level.

In order to ensure an unobstructed line of sight for the laser beam, the distance between the tip of the rod and the center of the reflector can be varied.

The pattern printed on the reflector foil ensures reliable measurement of distances and directions and allows a longer range than is possible with other target surfaces.

Reflector rod lengths	L1	L2	L3	L4	L5
POA 50 (metric)	100 mm	400 mm	700 mm	1,000 mm	1,300 mm
POA 51 (imperial)	4"	16"	28"	40"	52"

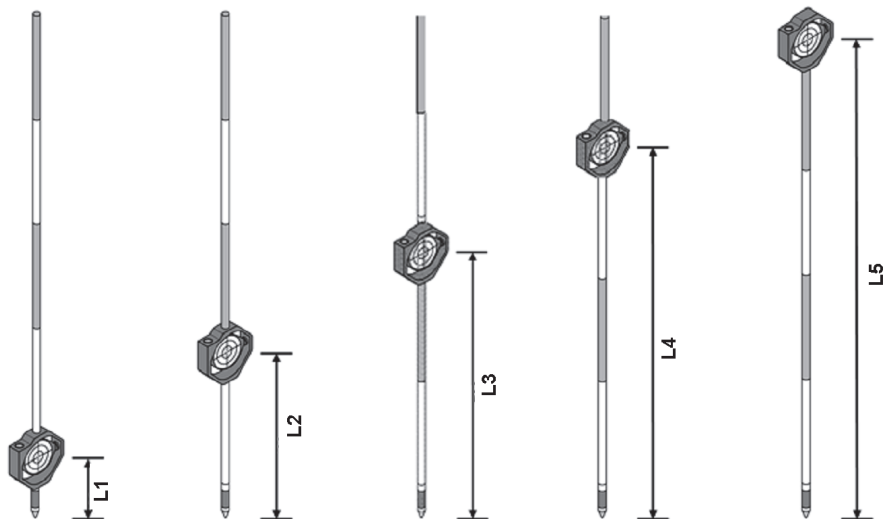

5.4 Height measurement

5.4.1 Height measurement

The tool can be used to measure heights or differences in height. Height measurements are made using the trigonometrical height measurement principle and are calculated accordingly.

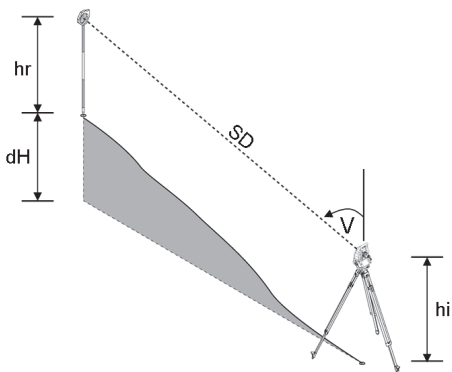

The height measurements take the **vertical angle** and the **slope distance** in conjunction with the **instrument height** and the **reflector height** into account.

$$dH = \text{COS}(VA) \cdot SD + HI - HR + (\text{corr})$$

In order to calculate the absolute height of the target point (point on the ground), the station height (Stat H) is added to the delta height.

$$H = \text{Stat H} + dH$$

5.5 Guide light

5.5.1 Guide light 7

The guide light can be switched on or off manually and the blink frequency adjusted to one of 4 different settings.

The guide light consists of two red LEDs incorporated in the telescope unit.

When switched on, one of the two LEDs blinks to clearly indicate whether the person is to the right or left of the sighting line.

A person at a distance of at least 10 m from the tool and standing approximately on the sighting line will see either the blinking or steady light more brightly, depending on whether they are positioned to the right or left of the sighting line. The person is positioned on the sighting line when both LEDs are seen to have the same intensity.

5.6 Laser pointer 6

The laser beam projected by the tool can also be switched on permanently.

When switched on permanently, the laser beam is often referred to as a "laser pointer".

When working indoors, the laser pointer can also be used as an aiming device or, respectively, to indicate the direction in which measurements are being made.

Outdoors, however, the beam is visible only under certain conditions so its use for this purpose is not really feasible.

5.7 Data points

The data from measurements taken with a Hilti total station is used to generate measured points.

Similarly, these measured points and their position descriptions are used in applications such as "Layout" or to define station locations.

Hilti total stations incorporate various features that facilitate and speed up the process of selecting points.

5.7.1 Selecting points

Point selection forms an important integral part of a total station system as points are generally measured and used repeatedly for laying out, for stations, as orientation aids and for comparative measurements.

Options for point selection

- From a plan
- From a list
- By manual entry

Select points from a plan

Control points (fixed points) are available for selection in graphical form.

Points can be selected on the display by touching them with a finger or the point of a stylus.

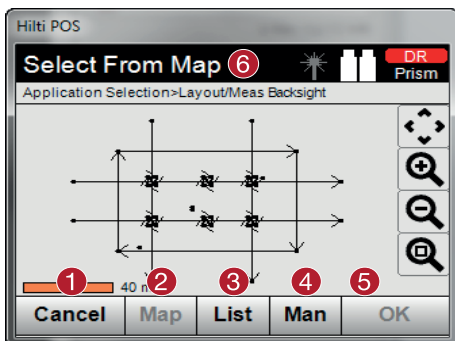

- ① Return to point entry
- ② Select the point from a plan
- ③ Select the point from a list
- ④ Enter point manually
- ⑤ Confirm point selection
- ⑥ Title bar

NOTE

Point data assigned to a graphical element cannot be edited or deleted on the total station. This can only be done using Hilti PROFIS Layout.

Selecting points from a list

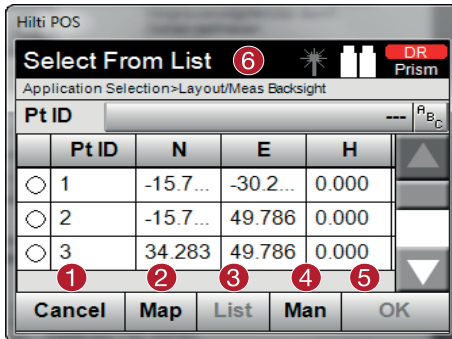

- ① Return to point entry
- ② Select the point from a plan
- ③ Select the point from a list
- ④ Enter point manually
- ⑤ Confirm point selection
- ⑥ Title bar

Entering points manually

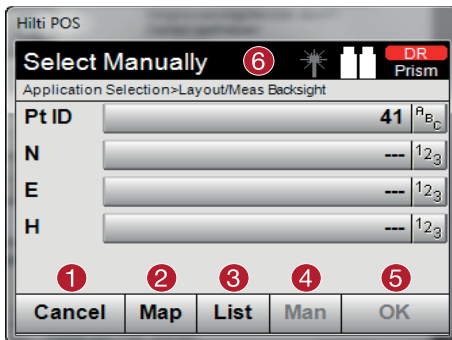

- ① Return to point entry
- ② Select the point from a plan
- ③ Select the point from a list
- ④ Enter point manually
- ⑤ Confirm point selection
- ⑥ Title bar

6 First steps

6.1 Batteries

The tool is equipped with two batteries which can supply power one after the other.

The current state of battery charge (both batteries) is always shown.

When changing batteries, one battery can remain in the tool and continue to provide power while the other battery is being charged.

When changing batteries while the tool is in operation and to prevent the tool switching itself off, it is recommended that the batteries are changed one after the other.

6.2 Charging the battery

After unpacking the tool, remove the AC adapter, charger and battery from their holders.

Charge the battery for approx. 4 hours.

6.3 Inserting and changing the battery **B**

Insert the charged battery into the tool with the battery connector underneath and facing the tool.

Secure the battery compartment cover carefully.

6.4 Checking functions

NOTE

Please note that this tool makes use of friction clutches for pivoting about the alidade and thus does not have to be locked at the horizontal drives.

The horizontal and vertical drives are of the continuous type, similar to those of an optical level.

Check the functions of the tool before initial use and at regular intervals in accordance with the following criteria:

1. Pivot the tool carefully by hand to the left and right and tilt the telescope up and down to check operation of the friction clutches.
2. Turn the horizontal and vertical drives carefully in both directions.
3. Turn the focussing ring fully to the left. Look through the telescope and turn the eyepiece ring to bring the cross hairs into focus.
4. With a little practice you can check the two optical sights on the telescope to ensure that they are in alignment with the object targeted by the cross hairs.
5. Check to ensure that the cover for the USB interfaces is closed securely before further use of the tool.
6. Check that the screws on the carrying handle are tight.





6.5 Control panel

The control panel consists of a total of 5 buttons with symbols plus a touch screen for interactive operation.

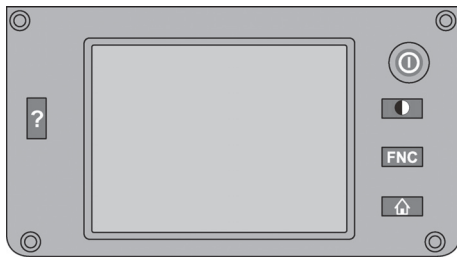
6.5.1 Function buttons

The function buttons are used for general operation of the tool.



	Switch the tool on or off.
	Switch the display backlight on or off.
	Select the FNC menu for additional settings.
	Cancel or end all active functions and return to the start menu.
	Show the help text for the current screen.

6.5.2 Size of the touch screen

The touch screen is approx. 74 x 56 mm (2.9 x 2.2 in) in size and has a resolution of 320 x 240 pixels.

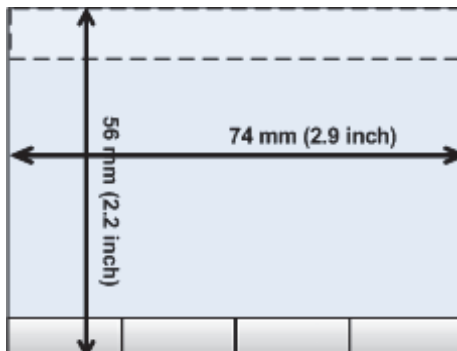

6.5.3 Division of the touch screen

The touch screen is divided into areas for operation of the tool and for displaying information to the user.

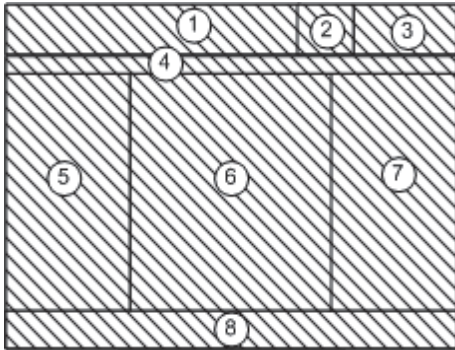

- ① Instructions and info for the user

- ② Battery and laser pointer status indicator

- ③ Time and date indicator and entry line

- ④ Menu hierarchy

- ⑤ Data field designations in ⑥

- ⑥ Data fields

- ⑦ Drawings to assist measuring operations

- ⑧ Bar containing up to 5 touch screen buttons

en

6.5.4 Touch screen – numerical keyboard

When numerical data is required to be entered, the appropriate keyboard appears in the display automatically. The keyboard layout is as shown in the illustration below.

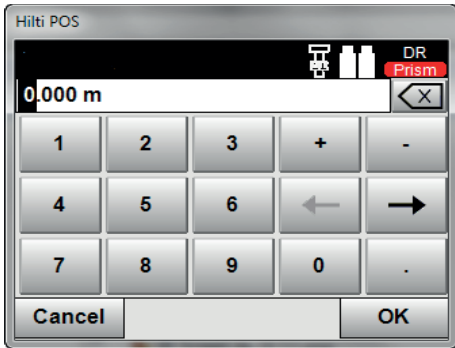

-  Cancel and return to previous screen.

-  Confirm and apply the entry.

-  Move the cursor to the left.

-  Move the cursor to the right.

-  Delete the character to the left of the cursor position. If there is no character to the left, the character at the cursor position will be deleted.

6.5.5 Touch screen – alphanumerical keyboard

When alphanumerical data is required to be entered, the appropriate keyboard appears in the display automatically. The keyboard layout is as shown in the illustration below.



	Cancel and return to previous screen.
	Switch to lower case letters.
	Switch to numerical keys.
	Confirm and apply the entry.
	Move the cursor to the left.
	Move the cursor to the right.
	Delete the character to the left of the cursor position. If there is no character to the left, the character at the cursor position will be deleted.

6.5.6 Touch screen – general operating controls

	Button for direct entry of numerical data, including symbols and decimal points.
	Button for direct entry of alphanumeric characters, including upper and lower cases.
	Select from a list. These lists may contain numerical or alphanumeric values and settings.
	A drop-down menu. In most cases, these menus provide a maximum of three options for the selection of settings.
	Example of a button in the bottom line of the display.

6.5.7 Laser pointer status indicator

The tool is equipped with a laser pointer.

	Laser pointer ON
	Laser pointer OFF

6.5.8 Battery condition indicators

The tool uses 2 lithium-ion batteries which can supply power at the same time or one after the other, depending on requirements.
 The tool switches from one battery to the other automatically.
 One of the batteries can thus be removed at any time, e.g. for charging, while continuing to use the tool with the other battery - so long as its capacity allows.

NOTE

The state of battery charge is indicated by the extent to which the battery symbol is “filled”.

6.6 Further information and operating instructions

Further information and operating instructions can be found online at:





6.7 Switching on / off

6.7.1 Switching on

Press and hold the on/off button for approx. 2 seconds.

NOTE

If the tool is starting from a fully switched-off state, the complete start-up procedure takes approx. 20 – 30 seconds, during which two different screens are displayed consecutively.

The end of the start-up procedure has been reached when the tool shows that it requires to be leveled (see section 6.8.2).

If the tool cannot be switched on, check that the batteries have been inserted correctly.

If the batteries have been inserted correctly and the tool still cannot be switched on, have it checked by Hilti Service.

6.7.2 Switching off



- ① Cancel and return to previous screen.
- ② The tool is switched off completely.
- ③ The tool is restarted. Any data not already saved will be lost.
- ④ End the Hilti application. the tool remains switched on.

Press the on / off button.

NOTE

Please note that when switching off or restarting, the user is asked to confirm this action, just to be sure.

You have three alternatives: 1. You may switch off the tool completely. 2. You may restart the tool. Unsaved data will then be lost. 3. You may end the Hilti application; the tool remains switched on.

6.8 Setting up the tool

6.8.1 Setting up over a mark on the floor or ground using the laser plummet





The tool should always be set up over a point marked on the floor or ground so that in case of measurement deviations it is possible to fall back on the data for the station or orientation point.

The tool features a laser plummet that is switched on automatically together with the tool.

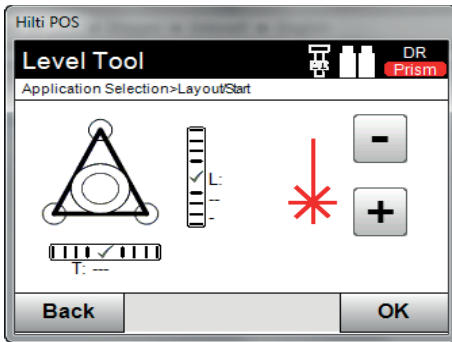
6.8.2 Setting up the tool 9

1. Set up the tripod with the center of the tripod head approximately over the point marked on the ground.
2. Mount the tool on the tripod by tightening the tripod screw and then switch the tool on.
3. Move two of the tripod legs with your hands until the laser beam strikes the mark on the ground.
NOTE Take care to ensure that the tripod head remains approximately horizontal.
4. Then press the points of the tripod legs into the ground by applying pressure with your foot.
5. Adjust the footscrews to eliminate any deviation of the laser point from the mark on the ground. The laser point must then be exactly in the center of the mark on the ground.
6. The circular bubble level can be centered by adjusting the tripod legs.
NOTE This is done by extending or retracting the leg at the opposite side of the tripod, depending on the direction in which the bubble is to be moved. This process may have to be repeated several times until the desired result is achieved.
7. Once the circular bubble level has been centered, align the laser plummet exactly with the mark on the ground by shifting the position of the tool laterally on the tripod plate.
8. Before the tool can be started, the electronic “bubble levels” must be centered by turning the footscrews so that the tool is reasonably level.
NOTE The arrows show in which direction the tribrach footscrews require to be turned in order to center the “bubbles”.
The tool can be started once this has been achieved.

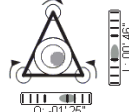

	Increase laser plummet intensity (settings 1–4).
	Reduce laser plummet intensity (settings 1–4).
	Confirms leveling.
	Laser plummet indicator symbol. The heavier the line, the more intense the laser plummet lights.
	Electronic “bubble level” indicator. Center the bubbles.

9. Once the electronic “bubble levels” have been centered, check that the laser plummet is aligned exactly with the mark on the ground and shift the position of the tool laterally on the tripod plate if necessary.
10. Start the tool.
NOTE The OK button becomes active when the level bubbles for line (L) and offset (O) are within a total inclination of 45°.

6.8.3 Setting up over a pipe using the laser plummet

Pipes are often used to mark points on the ground. In this case, the laser beam is projected into the pipe and the point cannot be seen.



Lay a piece of paper, plastic foil or other semi-translucent material on the pipe in order to make the laser point visible.

6.9 Dynamic exchange of data with design applications (optional)

6.9.1 Installation of Hilti PROFIS Connect

NOTE

System requirements:

Windows XP or higher (32 or 64-bit versions)

1 GB RAM

100 MB free hard disk space

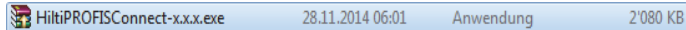

1. Start the HiltiProfisConnect-x.x.x.exe installation file.
NOTE The number **x.x.x** in the name of the installation file indicates the actual version number, e.g. "1.0.0".
2. Follow the installation instructions displayed on the screen.



Once Hilti PROFIS Connect has been successfully installed on your PC the application can be started by double-clicking the program symbol.

The symbol for "AutoUpdate" will also be shown in the task bar after Hilti PROFIS Connect has been installed. "AutoUpdate" makes it easy to update total station and PC applications from Hilti.

6.9.2 Starting Hilti PROFIS Connect for the first time

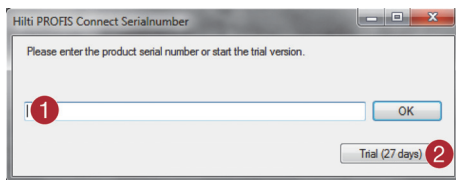

- ① License key entry field
- ② Button for activation of the 30-day demo mode

When started for the first time, Hilti PROFIS Connect requires a license key to be entered.

Hilti PROFIS Connect can be used as a demo version for a period of 30 days without entering a license key. After this period, the application can be used only after registration and when a license key has been entered.

An Internet connection is required for the registration process.

NOTE

A license key can be obtained from your Hilti representative.

6.9.3 Starting data exchange with a design application

The total station can exchange coordinates with a PC during use. To do this, the total station must be connected to a PC. The Hilti PROFIS Connect PC software (requires payment of a license fee) and a design application such as "Sema" or "Dietrich" must be installed on the PC.

1. Check that the applications on the total station have version number 2.2.0 or higher. Please contact Hilti Service if this is not the case.
2. Make sure that the "Hilti PROFIS Connect" software is installed on the PC that you connect to the total station when the total station is in use (see section 6.9.1.)
3. Make sure that a design application such as Sema or Dietrich is installed on the same PC.
4. Switch the total station on.
5. On the total station, activate data exchange with the "PROFIS Connect" application (see section 10.5.1) and select either the application "M & R Connect" or "Layout Conn" for data exchange.
6. Switch the PC on and start the design application.
7. Connect the PC to the total station using the USB cable provided with "Hilti PROFIS Connect".

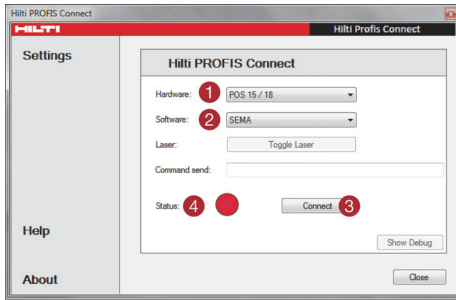

- ① Select total station type

- ② Select design application

- ③ Button for making the connection

- ④ Connection status: Not connected

8. Start "Hilti PROFIS Connect".
9. On the PC, in "Hilti PROFIS Connect", select the type of total station used.
10. In "Hilti PROFIS Connect" select the design application with which you wish to exchange data.

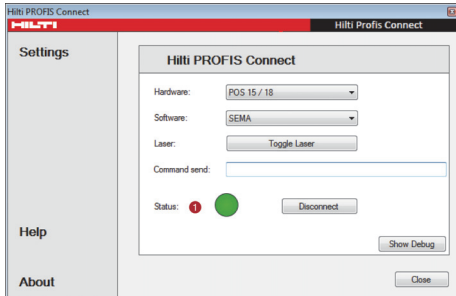

- ① Connection status: Connected

11. Press the "Connect" button.

NOTE If Hilti PROFIS Connect is not started last, then you must press the "Connect" button. However, if all previous steps have already been carried out then Hilti PROFIS Connect will make the connection without need to press the "Connect" button.

The status indicator lights green after a connection has been made successfully.

6.9.3.1 Connection error

A connection between the total station and the PC can be made only when you have started the PROFIS Connect application on the total station.

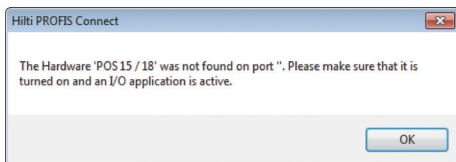

If the total station is not switched on or no data exchange application has been started, an error message will be displayed by the PC.

7 System settings

7.1 Configuration

The configuration button “Config”, which can be used to make the basic system settings, is located on the lowest line of the main configuration menu.

Menu buttons are located in the following configuration menu.

7.2 Settings

Possible settings

Coordinate display with settings	ENH, NEH, XYH, YXH, XYZ, YXZ
Decimal format	Dot (1000.0)
	Comma (1000,0)
Angle units	Degrees-minutes-seconds
	Gon
Angle resolution in display in accordance with angle unit selection	1", 5", 10"
	5cc, 10cc, 20cc
Distance units	Meters
	US feet, Int. feet, Ft/in 1/8, Ft/in 1/16
Zero setting for vertical circle	Zenith
	Horizon
Automatic power-off	On
	Off
Beep	On
	Off
Language	Language selection for the displays

7.3 Calibrating the display

This is a Windows function that can be used to correct the size and position of the display area.

Follow the instructions given by Windows.

7.4 Time and date

The date, time, time format and date format can be set here.

7.5 In-the-field calibration

The total station calibration function (in-the-field calibration) enables the operator to check the tool and to adjust the tool parameters electronically.

The tool is correctly adjusted when supplied.

The values to which the tool is set may change over time or due to temperature fluctuations, transport or aging.

The tool therefore incorporates a feature that allows the settings to be checked and, if necessary, corrected by carrying out in-the-field re-calibration.

This is done by setting up the tool securely on a tripod of good quality and targeting an easily visible, clearly discernible object within ± 3 degrees of horizontal at a distance of approx. 70 – 120 m.

NOTE

After this, follow the instructions on the display.

Interactive instructions for this procedure are shown in the display, so it is simply a matter of following the instructions.

This application calibrates and adjusts the following axes of the tool:

- Target axis
- VA collimation
- Dual-axis compensator (both axes)

NOTE

The in-the-field calibration procedure requires great care and each step must be carried out very exactly. Imprecise sighting or vibration of the tool can result in incorrect calibration values, leading to subsequent measurement errors.

NOTE

In the event of uncertainty the tool should be returned to Hilti Service for checking.

7.6 Hilti Repair Service

The Hilti Repair Service checks the tool and, if deviations from the specified accuracy are found, recalibrates it and checks it again to ensure conformity with specifications. The service certificate provides written confirmation of conformity with specifications at the time of the test.

Recommendation

- Have the tool checked at suitable intervals, depending on how heavily it is used.
- Have it checked by the Hilti Repair Service at least once a year.
- After exceptionally heavy use or rough treatment, have the tool checked by the Hilti Repair Service.
- The tool should be checked by the Hilti Repair Service before being used for particularly important work.

Having the tool checked by the Hilti Repair Service does not relieve the user of his/her obligation to check the tool before and during use.

7.7 Prism settings

NOTE

The prism settings are necessary as different prisms require different corrections for calculating distances. These corrections are mainly the prism constants that can be entered manually for the operator's prism.

7.8 Settings for EDM and standard target

This setting defines which distance measurement method and which target are to be used as standard. Although the system always remembers the last settings, there are some system states which require the instrument to revert to the standard settings.

Search parameters	Setting options
Standard EDM	Automatic target, manual, reflectorless (RL)
Standard target	POA 20 standard 360° prism POA 21 mini 360° prism POA 22 layout prism POA 23 wall prism Reflector foil POA 53 360° sliding prism User-defined prism

7.9 System information (I)

Display of system information

- Application software version
- Operating system version
- Total station type
- Total station serial number
- Total station firmware version

8 Function menu (FNC)

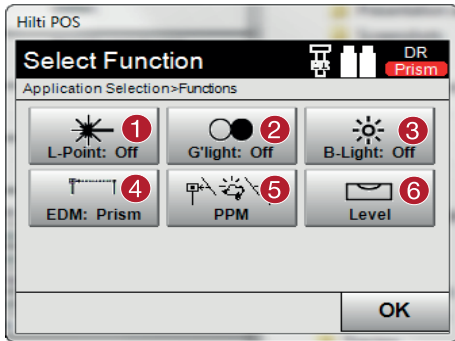

- ① Laser pointer on / off
- ② Switch the guide light on or off and vary the blinking frequency (sequence: off, 1 (slow) to 4 (fast))
- ③ Switch display illumination on/off or vary its intensity. The higher the brightness, the more power will be used.
- ④ Set standard measuring target
- ⑤ Menu for entering various atmospheric data
- ⑥ Level (bubble level): Bring up the electronic level and laser plummet

en

NOTE

You can press the “FNC” button at any time in order to set parameters, without having to cancel the application.

8.1 Guide light

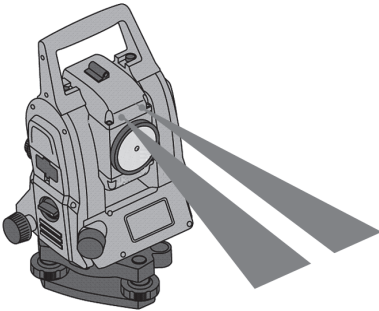

The guide light comprises an exit aperture on the telescope, half of which emits green and half red light.

Four different settings are possible:

- Off
- Flashing frequency – slow
- Flashing frequency – fast
- Flashing frequency – auto

With this setting the light flashes only if there is a loss of connection to the prism - otherwise it is off. In the activated state, a person can see either the green or the red light, depending on which side of the sighting line the person is located. A person is in the sighting line if both colors can be seen at the same time.

Settings	Setting options
Changed setting after each button touch.	Off Normal = standard flashing frequency Fast = fast flashing frequency Auto = standard flashing frequency ON when target tracking has lost the prism. Prism sighted = light OFF

8.2 Compensator

The tool is equipped with a dual-axis, electronic bubble level = compensator.

This compensator measures the slope of the tool. Following leveling of the tool, precise remaining inclinations are measured which are then used to calculate the corresponding angle corrections for steeper sightings. Faulty measurements can result from unstable surfaces, e.g. formwork. To avoid this, the compensator can be switched off. However, this means that no angle corrections are made for steeper sightings.

Settings	Setting options
Changed setting after each button touch.	OFF = no angle corrections due to tool tilt ON = angle corrections due to tool tilt

NOTE

For horizontal sightings, the residual inclination of the tool has no effect on the angle measurement.

8.3 Laser pointer

The tool is equipped with an EDM with various settings, depending on the objective. With the EDM setting “reflectorless measuring (RL)”, the visible laser beam can be switched on permanently = laser pointer.

The laser pointer can be used indoors as a visible measuring and layout point.

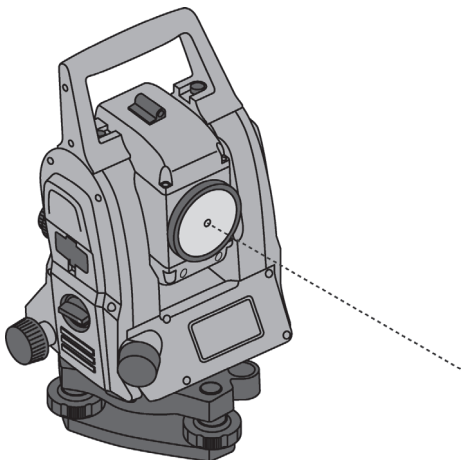

WARNING

The laser pointer belongs to laser class 3R.

Avoid direct eye contact.

8.4 Correction of atmospheric influences

The tool uses laser light to measure distances. As a fundamental principle, when light passes through the air, its speed is changed due to the density of the air. This influence varies according to the air density. Air density depends to a great extent on air pressure and air temperature and to a significantly lesser extent on air humidity. If distances are to be measured accurately, it is essential that atmospheric influences are taken into account. The tool calculates and corrects the corresponding distances automatically, but the temperature and pressure of the surrounding air must first be entered. These parameters can be entered in various units.

When the ppm button is pressed, atmospheric parameters can be entered to correct each distance measured by the corresponding ppm variable. Select the applicable units and enter the pressure and temperature (see table).

Settings	Setting options
Air pressure unit	hPa mmHg mbar inHg psi
Temperature unit	°C °F

NOTE

The distance corrections are output in ppm (parts per million). 10 ppm correspond to 10 mm / kilometer or 1 mm / 100 m.

8.5 EDM settings

Various measurement settings can be selected for the EDM (Electronic Distance Meter) using the EDM button.

Settings	Setting options
Changed setting after each button touch.	Prism Auto = automatic prism tracking and continual distance measurement Prism Manual = distance measurement at the touch of a button RL+Pointer = reflectorless distance measurement with laser pointer switched on

8.6 Display illumination

Display illumination can be switched on / off using the display illumination button.

When switched on, the intensity of the illumination can be varied over five levels from 1/5 to 5/5 by continuing to press the display illumination button.

NOTE

The brighter the display, the more power is consumed.

8.7 Bubble level (compensator)

Before applications can be started, the electronic “circular bubble level” must be centered by turning the footscrews so that the tool is reasonably level. The arrows show in which direction the tribrach footscrews require to be turned in order to center the “bubbles”

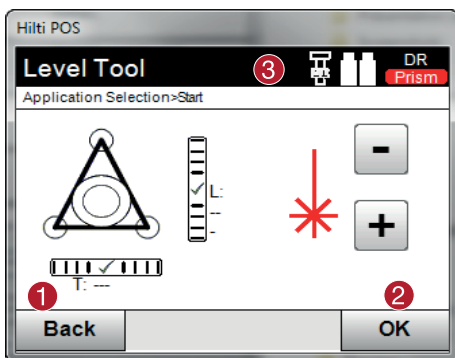

- ① Return to previous dialog
 - ② Confirm current dialog
 - ③ Title bar: Level tool
-
- Increase laser plummet intensity (settings 1 - 4)
 - Reduce laser plummet intensity (settings 1 - 4)

NOTE

The confirm button (OK) becomes active when the level bubbles for longitudinal (L) and transverse (T) are within a total inclination of 50". The heavier the line for the laser plummet light symbol, the more intense the laser light.

8.8 Help

The “Help” button can be used to call up the help screen for the current dialog at any point in the system. The help screen refers to the content of the current dialog.

en 9 Functions required for various applications

9.1 Projects

A project has to be opened or created before the total station is used for an application.

If at least one project already exists then the project selection screen will be displayed. If no project exists then the screen for creation of a new project will be displayed.

All data are assigned to the active project and saved accordingly.

9.1.1 Showing the active project

If one or more projects are already present in memory and one of these is to be used as the active project, the project has to be confirmed each time an application is restarted, when another project is selected or when a new project is created.

9.1.2 Selecting a project

From the list shown, select the project that is to be used as the current project.

9.1.3 Creating a new project

All data is always assigned to a project.

A new project should be created when data is assigned to something new and the data is to be used only for that purpose.

The date and time of creation are saved when a new project is created and the number of stations and points within the project is set to zero.

NOTE

An error message is displayed when an incorrect entry is made and the user is requested to re-enter the data.

9.1.4 Project information

The current status of the project is shown with the project information, e.g. date and time of creation, number of stations and total number of the points saved.

9.2 Setting a station and orientation

Please pay particular attention to the information given in this section.

Setting a station is one of the most important operations when using a total station and must be carried out with great care.

The simplest and most reliable method of achieving this involves setting up the tool over a (known) point on the floor or ground and using a reliable target point.

The possibility of setting the station “anywhere” offers greater flexibility but presents risks in that errors may not be identified and then transferred or multiplied as the work proceeds, etc.

Moreover, this method requires a little experience in selecting the tool position relative to the reference points used for position calculation.

NOTE

Please remember: If the station is set incorrectly, everything measured subsequently from this station will also be incorrect, i.e. the actual applications carried out, such as measuring, layouts or staking out, etc.

9.2.1 Overview

Setting of the station and orientation is required in order to position the tool in the corresponding coordinate environment. Setting the station positions the tool within the coordinate system, and orientation aligns the horizontal circle of angles.

The process for setting the station offers various options:

1. Select setting type

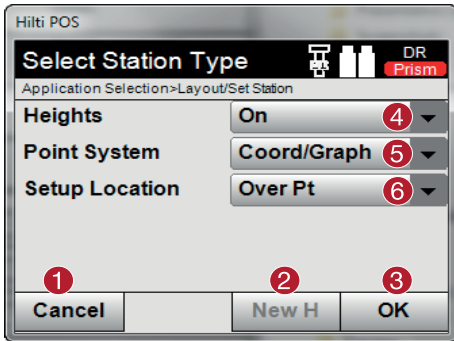

- ① Return to previous dialog
- ② When heights are used, a new height can be set (even after setting the station has been completed)
- ③ Confirm dialog
- ④ Switch use of heights on / off
- ⑤ Selecting the point system; coordinates or control lines
- ⑥ Select station setting type: Over a point or "anywhere"

en

NOTE

If heights are switched off when setting the station, all relevant height values (height, HR, HI) are not displayed!

If, when setting the station, the option "Station anywhere" is selected, the coordinate system is defined by way of the reference points. All reference points have coordinates. If, when setting the station, the control line is selected, the coordinate system is defined by way of the control line points. The control line points can be measured directly, and no coordinates have to be known (in contrast to stationing anywhere).

9.2.2 Setting the station over a point

On many construction sites, measured points with coordinates already exist, or the positions of parts of the structure, building control lines or foundations etc. are already described with coordinates.

The tool is set up over a point marked on the floor or ground, the position of which is defined by coordinates and from which the points or items to be measured are easily visible. Special care must be taken to ensure that the tripod stands steadily and securely.

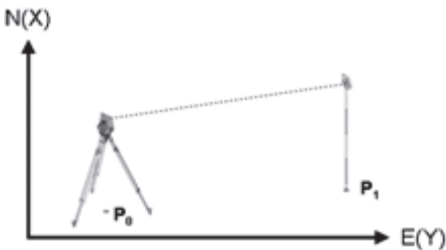

The tool is positioned at a point defined by coordinates **P0** and, for the purpose of orientation, is aimed at another point defined by coordinates **P1**. The tool calculates the position within the coordinate system.

For better identification of the orientation point, the distance can be measured and compared with the distance calculated from the coordinates. This makes correct selection of the target point more reliable.

NOTE

If the coordinate point **P0** also has a height, this will first be used as the station height. The height of the station can be redetermined and changed at any time before the station is set finally.

1. Select station type

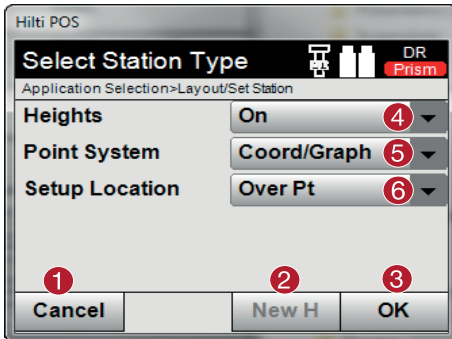

- ① Return to previous dialog
- ② When heights are used, a new height can be set (even after setting the station has been completed)
- ③ Confirm dialog
- ④ Switch use of heights on / off
- ⑤ Selecting the coordinates of the point system
- ⑥ Select the station setting type: Station set over a point

2. Select station point

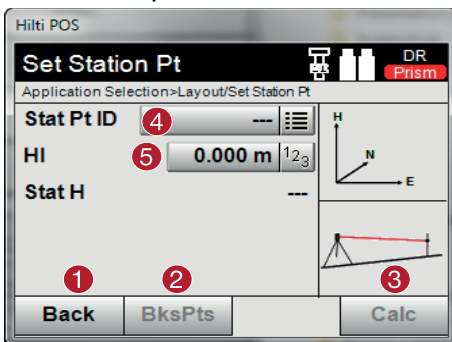

- ① Return to previous dialog
- ② Start the dialog to measure the orientation points
- ③ Start the calculation (possible only after at least one orientation point has been measured)
- ④ Select station point
- ⑤ Setting the height of the device

3. Select orientation points

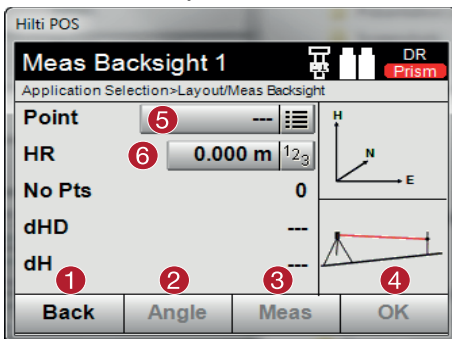

- ① Return to previous dialog
- ② Set the orientation angle (only the angle is to set, no measurement is taken)
- ③ Take the measurement to the orientation point
- ④ Confirm dialog
- ⑤ Select orientation point
- ⑥ Set the reflector height

4. Select the orientation points or start the calculation

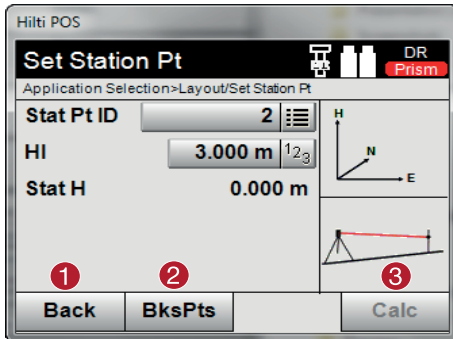

- ① Return to previous dialog
- ② Dialog for measuring orientation points. Start the dialog again for each orientation point.
- ③ Start the calculation (possible only after at least one orientation point has been measured)

en

If additional orientation points are to be measured, use ② again to select an additional orientation point. If not, use ③ to start the calculation.

5. Set station

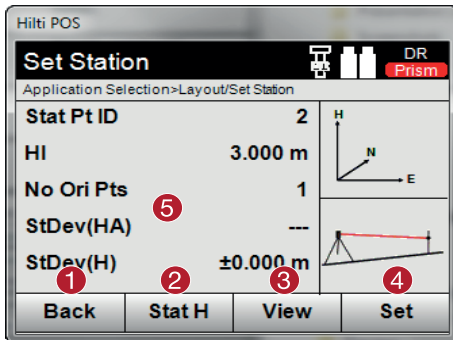

- ① Return to previous dialog
- ② Set the height of the station (see no. 6)
- ③ Display results
- ④ Set station
- ⑤ If there are more than two orientation points the standard deviations "StDev(HA)" and "StdDev (H)" are displayed.

6. Determine the height of the station

If the station point and / or the connected points have heights, these heights are averaged and adopted. If the points have no height, the height can now be determined from a reference point or from a height mark.

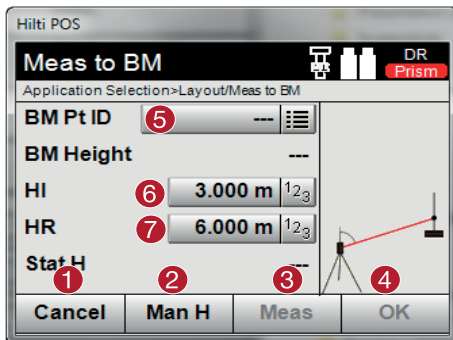

- ① Return to previous dialog
- ② Entering the height manually
- ③ Initiate measurement
- ④ Confirm dialog
- ⑤ Selecting height points
- ⑥ Setting the height of the device
- ⑦ Set the reflector height

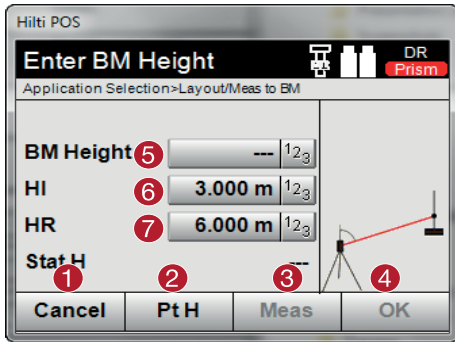

- ① Return to previous dialog
- ② Select the height above the point
- ③ Initiate measurement
- ④ Confirm dialog
- ⑤ Select the height point / height mark
- ⑥ Setting the height of the device
- ⑦ Set the reflector height

After entering a height manually, ③ can be used to target and measure a height point. The station height is calculated on the basis of the measurements to the height point / height mark.

After entering the heights manually, ④ can be used to set the station height directly, without having to take a measurement.

NOTE

When the "Heights" option is active, a height must be assigned to the station, i.e. a height value must exist. If a station height is not set or available, a fault message appears with the prompt to set the station height.

9.2.3 Setting a station "anywhere"

Setting the station "anywhere" allows the position of the station to be defined by measuring the angles and distances to two reference points. The ability to set the station "anywhere" is used when it is not possible to set it over a point or when the line of sight to the points to be measured is obstructed. Extra care must be taken when setting the station "anywhere". Additional measurements are taken in order to set the station "anywhere". Additional measurements always present a risk of errors. Care must also be taken to ensure that the geometry of the situation allows a usable position to be achieved.

The tool checks the basic geometric relationships in order to ensure that a usable position can be calculated and issues a warning in critical situations. Nevertheless, the user of the tool is obliged to exercise special caution in this respect as the software is not capable of recognizing all potentially critical situations.

Setting up the tool "anywhere"

An unobstructed and convenient location should be chosen for setting up the tool, where at least two coordinate points are clearly visible and where a good line of sight to the points to be measured can be ensured as far as possible. It is recommended that a mark is always first made on the ground or floor and the tool then set up over this mark. This allows the position to be checked subsequently in the event of uncertainties.

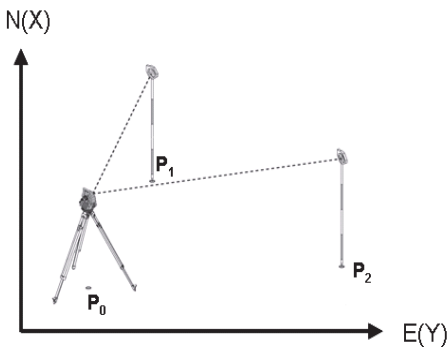

The tool is positioned at any point P_0 and measures, one after the other, the angles and distances to two or more reference points with coordinates, P_1 , P_2 and P_X . The position of the tool P_0 is then calculated from the measurements taken to the two reference points.

1. Select station type

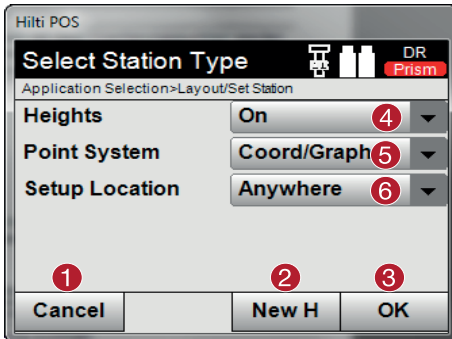

- ① Return to previous dialog
- ② When heights are used, a new height can be set (even after setting the station has been completed)
- ③ Confirm dialog
- ④ Switch use of heights on / off
- ⑤ Selecting the coordinates of the point system
- ⑥ Select station setting type: Setting a station "anywhere"

2. Give the station a name

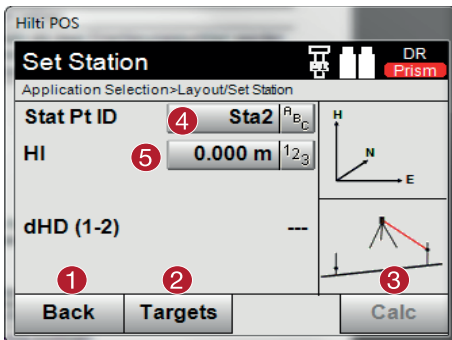

- ① Return to previous dialog
- ② Start the dialog to measure the reference points
- ③ Start the calculation (possible only after at least 2 reference points have been measured)
- ④ Give the station a name
- ⑤ Setting the height of the device

3. Select the reference points

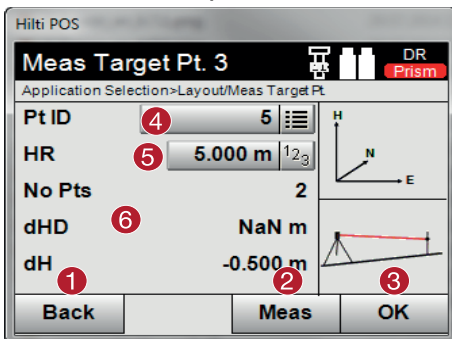

- ① Return to previous dialog
- ② Take the measurement to the reference point
- ③ Confirm dialog
- ④ Select the reference point
- ⑤ Set the reflector height
- ⑥ Display the reference points already measured and display the differences.

Select a reference point and take the measurement.

Repeat steps ④ and ⑤ until the desired number of reference points for determination of the station have been measured.

NOTE

At least two reference points have to be measured in order to be able to calculate a station.

4. Select the orientation points or start the calculation

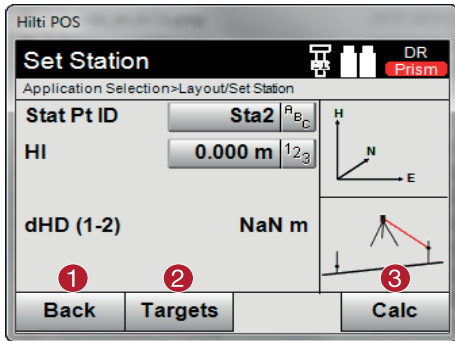

- ① Return to previous dialog
- ② Start the dialog to measure the reference points
- ③ Start the calculation (possible only after at least 2 reference points have been measured)

5. Set station

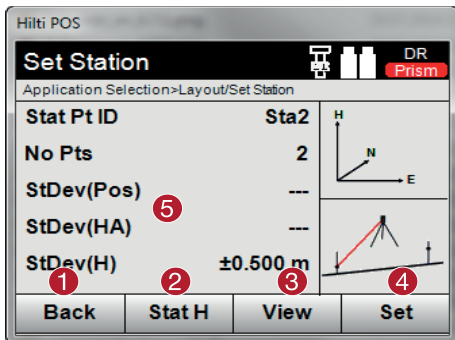

- ① Return to previous dialog
- ② Set the height of the station (see "6. Setting the height of the station")
- ③ Display results
- ④ Set station
- ⑤ If there are more than two reference points the standard deviations "StDev(HA)" and "StdDev (H)" are displayed.

6. Determine the height of the station

If the station point and / or the connected point(s) have heights, these heights are averaged and adopted. If the points have no height, the height can now be determined from a reference point or from a height mark.

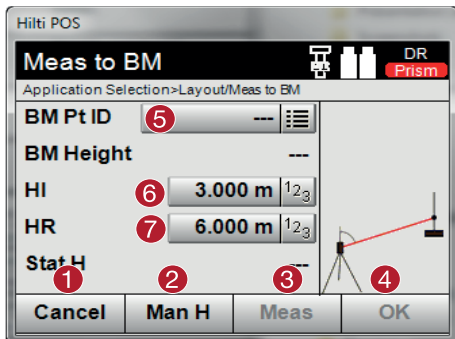

- ① Return to previous dialog
- ② Entering the height manually
- ③ Initiate measurement
- ④ Confirm dialog
- ⑤ Selecting height points
- ⑥ Setting the height of the device
- ⑦ Set the reflector height

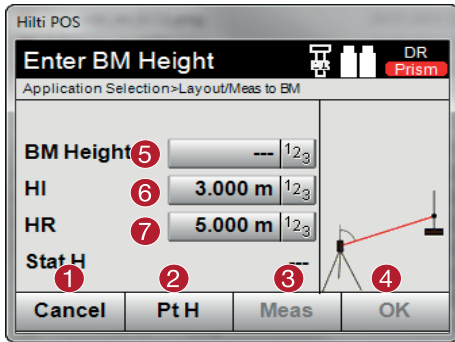

- ① Return to previous dialog

- ② Select the height above the point

- ③ Initiate measurement

- ④ Confirm dialog

- ⑤ Select the height point / height mark

- ⑥ Setting the height of the device

- ⑦ Set the reflector height

en

After entering a height manually, ③ can be used to target and measure a height point. The station height is calculated on the basis of the measurements to the height points or marks.

After entering the heights manually, ④ can be used to set the station height directly, without having to take a measurement.

NOTE

When the "Heights" option is active, a height must be assigned to the station, i.e. a height value must exist. If a station height is not set or available, a fault message appears with the prompt to set the station height.

9.2.4 Station with building control line

Two options are available:

1. Control line with 2 points
2. Control line with 3 points

9.2.4.1 Control line with 2 points

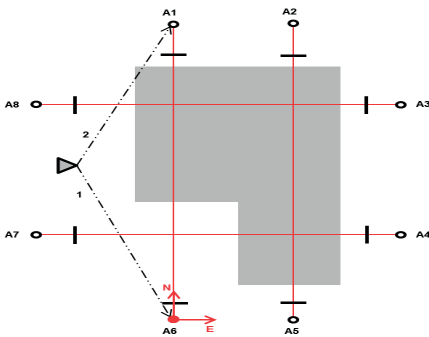

The tool is positioned at any point and measures, one after the other, the angles and distances to two control line points. The position of the tool is subsequently calculated from the measurements to the two control line points and the zero point of the coordinate system is set as the first measured control point. Orientation (longitudinal value) is toward the second measured control line point. The coordinates of the control line points do not have to be known.

9.2.4.2 Control line with 3 points

en

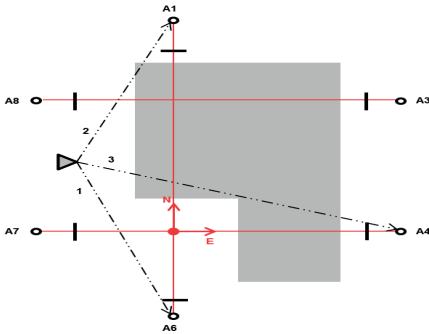

The tool is positioned at any point and measures, one after the other, the angles and distances to three control line points. Subsequently, the position of the tool is calculated from the measurements taken to the control line points. The zero point of the coordinate system is the projection of the third measured control line point, perpendicular to the axis of the two points measured first. Orientation (longitudinal value) is toward the second measured control line point. The coordinates of the control line points do not have to be known.

1. Select setting type

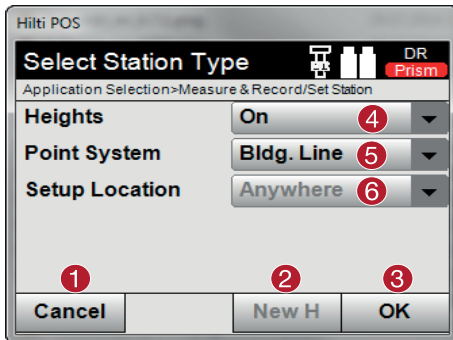

- ① Return to previous dialog
- ② When heights are used, a new height can be set (even after setting the station has been completed)
- ③ Confirm dialog
- ④ Switch use of heights on / off
- ⑤ Selecting the point system
- ⑥ Select station setting type: Over a point or "anywhere"

2. Select control line point 1

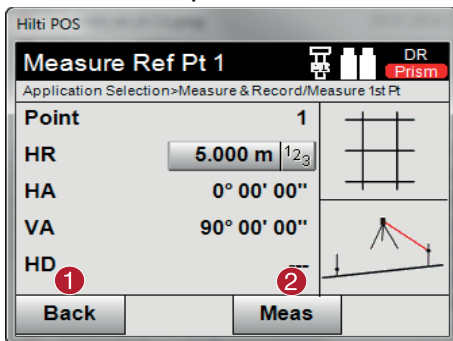

- ① Return to previous dialog
- ② Take the measurement to the reference point

3. Select control line point 2

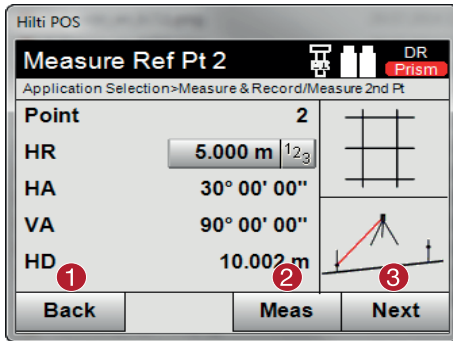

- ① Return to previous dialog
- ② Take the measurement to the reference point
- ③ Confirm dialog

en

NOTE

When measuring the 3 control line points, also measure the third point.

4. Set station

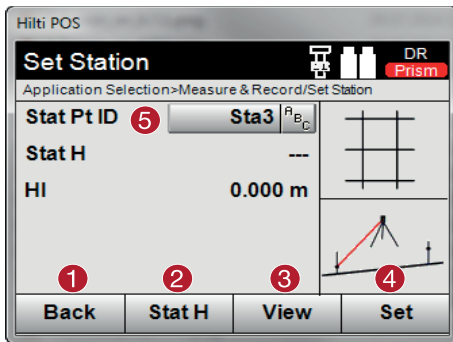

- ① Return to previous dialog
- ② Set the height of the station (see no. 5)
- ③ Display results
- ④ Set station
- ⑤ Display the name of the station

5. Determine the height of the station

If the points have a height, these heights are averaged and adopted. If the points have no height, the height can now be determined from a reference point or from a height mark.

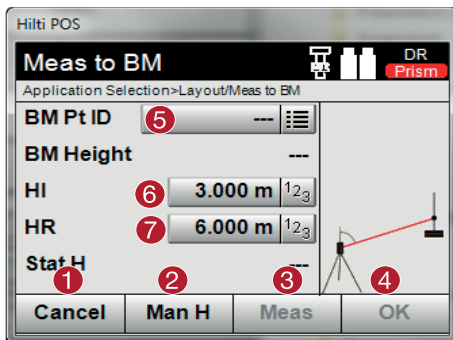

- ① Return to previous dialog
- ② Entering the height manually
- ③ Initiate measurement
- ④ Confirm dialog
- ⑤ Selecting height points
- ⑥ Setting the height of the device
- ⑦ Set the reflector height

After entering a height manually, ③ can be used to target and measure a height point. The station height is calculated on the basis of the measurements to the height points or marks.

After entering the heights manually, ④ can be used to set the station height directly, without having to take a measurement.

NOTE

When the "Heights" option is active, a height must be assigned to the station, i.e. a height value must exist. If a station height is not set or available, a fault message appears with the prompt to set the station height.

9.2.5 Set station

The station is always saved in internal memory. If the station name already exists in memory, the station must be renamed. i.e. a new name assigned to it.

9.3 Setting up the tool with height

If heights are also to be used in addition to setting the station and orientation, i.e. target heights are to be determined or laid out, the height of the center of the telescope must also be defined.

Methods for setting the height

- If the height of the point on the floor or ground is known when setting up over a point on the floor or ground, the height of the tool is measured. The height of the center of the telescope is the sum of these two values.
- If the height of the point on the floor or ground is not known, e.g. when setting up "anywhere", the height at the center of the telescope can be determined and transferred back to the tool by measuring the angle and distance to a point or mark for which the height is known.

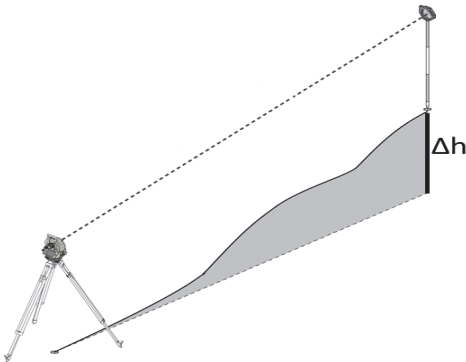

Dialog for determining height

Hilti POS

Meas to BM DR Prism

Application Selection>Layout/Meas to BM

BM Pt ID ⑤

BM Height ---

HI ⑥ 3.000 m 1₂3

HR ⑦ 6.000 m 1₂3

Stat H ① ② ③

Cancel Man H Meas OK

- ① Return to previous dialog
- ② Entering the height manually
- ③ Initiate measurement
- ④ Confirm dialog
- ⑤ Selecting height points
- ⑥ Setting the height of the device
- ⑦ Set the reflector height

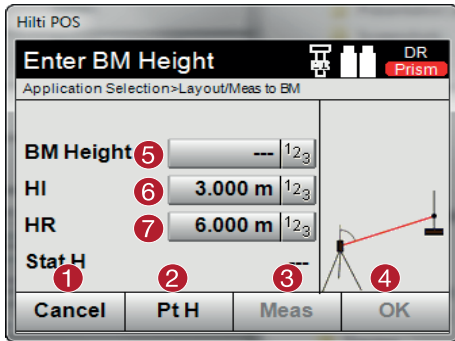

- ① Return to previous dialog
- ② Select the height above the point
- ③ Initiate measurement
- ④ Confirm dialog
- ⑤ Select the height point / height mark
- ⑥ Setting the height of the device
- ⑦ Set the reflector height

en

After entering a height manually, ③ can be used to target and measure a height point. The station height is calculated on the basis of the measurements to the height point / height mark.

After entering the heights manually, ④ can be used to set the station height directly, without having to take a measurement.

NOTE

When the “Heights” option is active, a height must be assigned to the station, i.e. a height value must exist. If a station height is not set or available, a fault message appears with the prompt to set the station height.

10 Applications

10.1 Horizontal layout (Horz. layout)

10.1.1 Principle of the layout procedure

In principle, the Hilti total station system POS 15/18 comes with two different layout procedures - prism or laser mode - depending on the EDM mode.

Layout procedure

- Layout with prism (see section 10.1.2)
 - With the prism, points are set out when they are either outside or on the ground - that is, when work can be carried out with a prism and a rod.
- Layout with a visible laser pointer including distance measurement (see section 10.1.3)
 - The laser pointer is used particularly for setting out indoors, where the laser spot can be seen most clearly, for example in large industrial buildings. The total station is suitable for use at distances of over 5 m and where there are suitable light conditions, for example, not in bright sunlight.

10.1.2 Setting out (layout) with prism

In this procedure, the EDM is set to “Prism”. Setting out with the prism corresponds to navigation to the layout position.

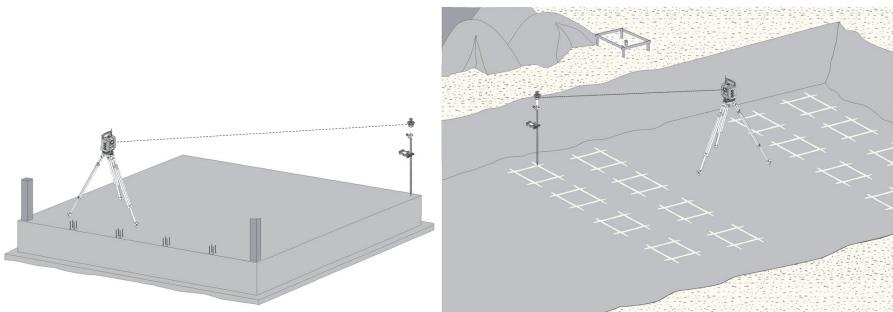

10.1.2.1 Procedure for application “Layout with prism”

To start the application “Horizontal layout”, press button **Horz. Layout** in the main menu.

1. Start “Layout” dialog

Procedure for application

1. Selecting a project
2. Station definition and station setup

en

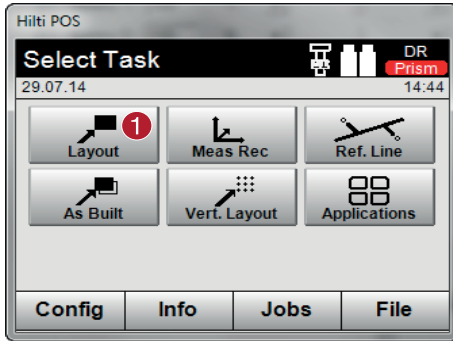

- ① Selecting the horizontal layout application

2. “Layout point” entry dialog

Point coordinates for the layout points can be determined in three different ways:

Options for determining the point coordinates of layout points

- Enter manually
- Select from a list of saved points
- Select from a CAD drawing with saved points

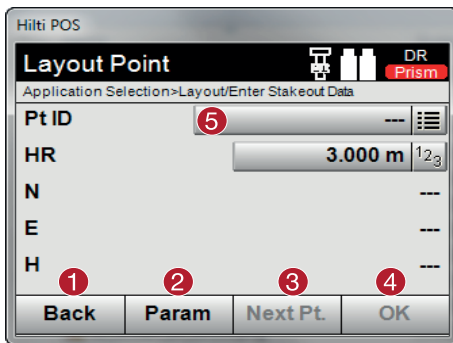

- ① Return to previous view
- ② Enter the layout settings. Sorting criteria for automatic point suggestion, automatic point tracking (on/off), layout tolerances, measuring delay, in order to align the prism rod sufficiently before the distance measurement
- ③ Select the next point if automatic point suggestion is selected in the settings
- ④ Confirm dialog
- ⑤ Entry and selection field for layout point

3. Layout dialog (graphic display)

- Dialog with rough layout information for finding the new layout position
- Dialog with layout depiction for precise setting-out with graphic auto-zoom and numerical layout values. This dialog is called up automatically as soon as the prism position is within a radius of less than three meters.

In both dialogs, the layout corrections are displayed numerically in the top right-hand corner. The arrows show the direction in which the prism must be moved to reach the layout point. The arrow for the left/right direction always refers to the line between the current prism position and the total station.

Rough layout dialog

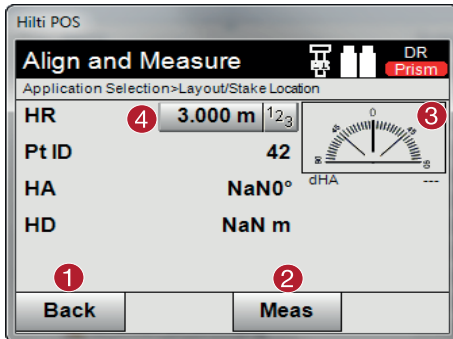

- ① Return to previous dialog
- ② Take the measurement
- ③ Show the direction in which the point to be laid out lies
- ④ Enter the reflector height (if heights are being used)

en

Detailed layout dialog

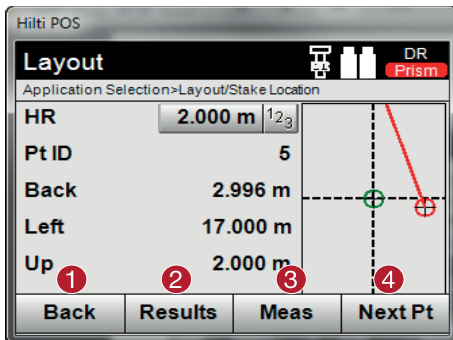

- ① Return to previous dialog
- ② Save the result
- ③ Initiate measurement
- ④ Select the next point

4. Memory dialog (optional)

The memory dialog can be used to store the current layout position for documentation purposes. A distance is automatically measured and the deviations from the given coordinates are displayed and saved when the display is confirmed. The stored data can be read, saved and printed using the PC software Hilti PROFIS Layout.

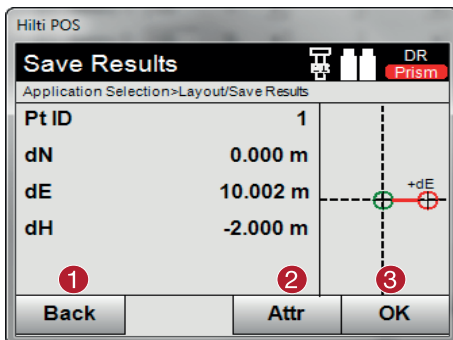

- ① Return to previous dialog
- ② Enter attribute values
- ③ Confirm

NOTE

If the option to exclude heights is activated when setting up the station, height values and all associated information are not displayed.

Saving layout data

Point number	Name of layout point
Northings (specified)	The northings entered refer to the coordinate reference system.
Eastings (specified)	The eastings entered refer to the coordinate reference system
Height (specified)	Height entered
Northings (measured)	Measured northings refer to the coordinate reference system
Eastings (measured)	Measured eastings refer to the coordinate reference system
Height (measured)	Measured height
dN	$dN = \text{Northings (measured)} - \text{Northings (entered)}$
dE	$dE = \text{Eastings (measured)} - \text{Eastings (entered)}$
dH	$dH = \text{Height (measured)} - \text{Height (entered)}$
Attribute 1 – Attribute 5	Attributes assigned to the point

10.1.3 Layout with visible laser (laser pointer)

In this procedure, the EDM is set to “Laser ON”. This ensures that for practical setting out with the “red dot”, the layout point is directly selected and the layout position virtually marked with the red dot.

As the red laser is more easily seen in lower ambient light, this application is primarily used indoors.

To enable the layout point to be directly selected in three dimensions, the station must be set up with the height values specified.

It is, however, also possible to set out using floors or ceilings without specification of heights. The laser must first be trained onto the area. In this case, the software attempts to find the corresponding point position or the corresponding plumbline on the area in question.

NOTE

The application “Layout” with the “red” laser is suitable for layouts on floors and ceilings. The application is not suitable for layouts on the wall.

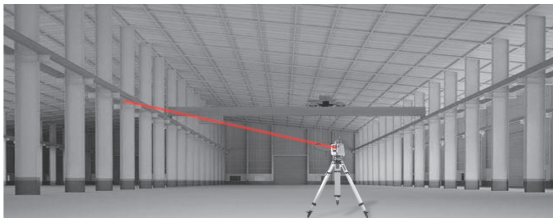

10.1.3.1 Procedure for application “Layout with visible laser”

1. Start “Layout” dialog

To start the application “Horizontal layout”, press button **Horz. Layout** in the main menu.

- Selecting a project
- Station definition and station setup

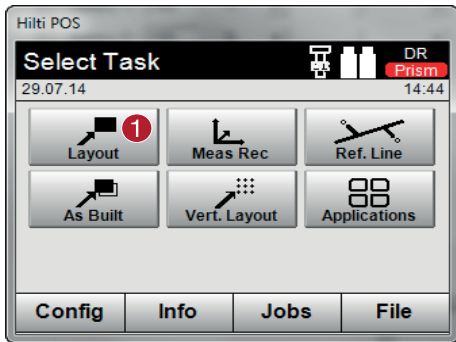

① Selecting the horizontal layout application

2. "Layout point" entry dialog

Options for determining the point coordinates of layout points

- Enter manually
- Select from a list of saved points
- Select from a CAD drawing with saved points

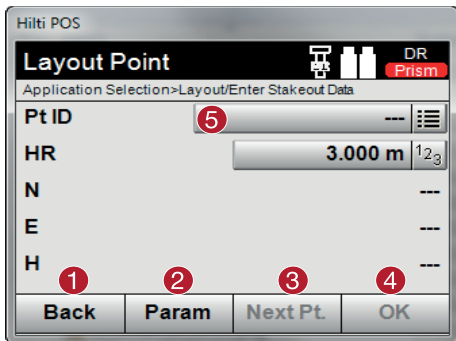

① Return to previous view

② Enter the layout settings. Sorting criteria for automatic point suggestion, automatic point tracking (on/off), layout tolerances, measuring delay, in order to align the prism rod sufficiently before the distance measurement

③ Select the next point if automatic point suggestion is selected in the settings

④ Confirm dialog

⑤ Entry and selection field for layout point

NOTE

Switch the EDM to laser mode here at the latest. This can be done either in the "FindMe" dialog or in the "FNC" dialog.

Once entry of the layout point has been confirmed, the laser point is directly aligned to the target position, if the station has been used with height settings. Otherwise the currently targeted area is used.

The target position is only valid if the target point is directly on the target surface area. If this is not the case, the current position is compared with the target position. If the position is outside the set layout tolerance, this is displayed in an additional dialog. The operator can decide whether the plumb point should be steered onto the current surface. If the plumb position is to be selected, the laser point is projected in iteration steps onto the plumbline of the specified target point on the current surface.

The following sketch shows how the plumb position is reached from the entered target position (black dot) in 3 iteration steps.

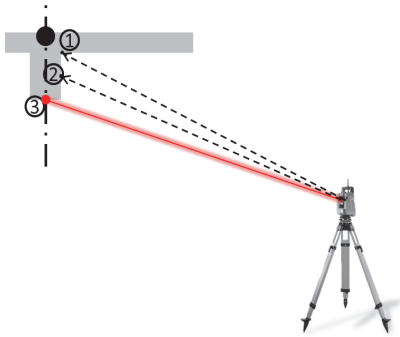

NOTE

Pay attention to the layout tolerance entry.

As soon as the difference in positions is within the layout tolerance, the iteration process is completed.

3. Layout dialog (graphic display)

The graphic display directly shows the precise layout dialog as the red dot “travels” directly to the layout position. In the dialog, the layout corrections are displayed numerically in the top right-hand corner. The values are “quasi” zero (within the set layout tolerance), as the red dot points directly to the position of the layout point – all that remains is the difference in height.

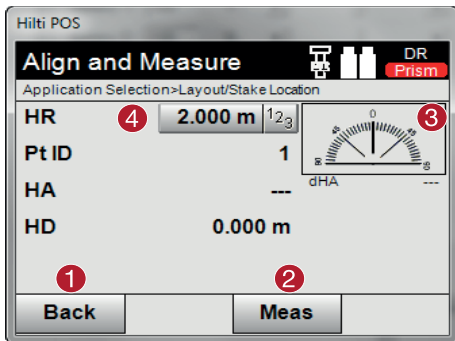

- ① Return to previous dialog
- ② Take the measurement
- ③ Show the direction in which the point to be laid out lies
- ④ Enter the reflector height (if heights are being used)

NOTE

If the option to exclude heights is activated when setting up the station, height values and all associated information are not displayed. The other screens shown are the same as described in the previous section.

4. Memory dialog (optional)

The memory dialog can be used to store the current layout position for documentation purposes. A distance is automatically measured and the deviations from the given coordinates are displayed and saved when the display is confirmed. The stored data can be read, saved and printed using the PC software Hilti PROFIS Layout.

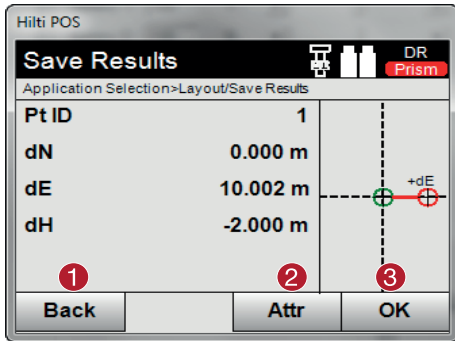

- ① Return to previous dialog
- ② Enter attribute values
- ③ Confirm

en

NOTE

If the option to exclude heights is activated when setting up the station, height values and all associated information are not displayed. The other screens shown are the same as described in the previous section.

Saving layout data

Point number	Name of layout point
Northings (specified)	The northings entered refer to the coordinate reference system.
Eastings (specified)	The eastings entered refer to the coordinate reference system
Height (specified)	Height entered
Northings (measured)	Measured northings refer to the coordinate reference system
Eastings (measured)	Measured eastings refer to the coordinate reference system
Height (measured)	Measured height
dN	$dN = \text{Northings (measured)} - \text{Northings (entered)}$
dE	$dE = \text{Eastings (measured)} - \text{Eastings (entered)}$
dH	$dH = \text{Height (measured)} - \text{Height (entered)}$
Attribute 1 - Attribute 5	Attributes assigned to the point

NOTE

Attributes are descriptions of the point and can be taken together with the point coordinates directly from AutoCad or Revit using Hilti Point Creator or can be entered manually

For Hilti products such as anchors, rails, etc., the item numbers, description, layer, type of graphical element and color are taken from AutoCad or Revit. The CAD data can also contain 2D or 3D data and attributes (but does not have to).

10.2 Measure and record

10.2.1 The principle of "Measure and record"

"Measure and record" can be used to measure points with an unknown position.

Distance measurements can be measured using the prism or laser. Prism measurements are suitable for use outdoors or in areas where a person can move with a prism. Measurements with the laser are suitable for measuring in areas that are difficult to access with the prism or indoors, where the laser spot can be seen more easily.

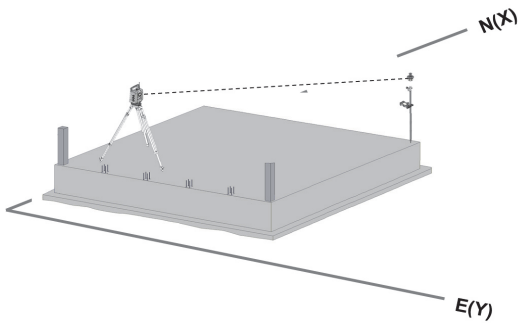

Point measurements with the prism can be carried out by tracking the prism with the EDM in “auto mode” and taking a measurement and saving data at each position. Alternatively, a prism can be manually sighted and the EDM operated in manual mode.

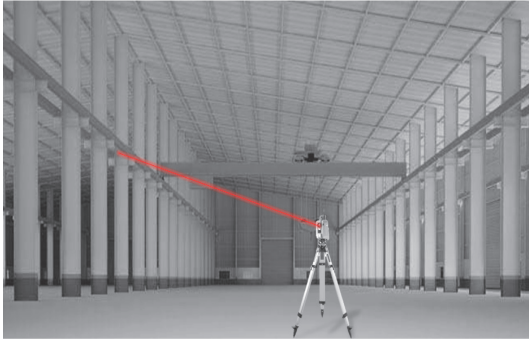

Point measurements with the visible laser can be carried out manually using the motorized drives or the remote control joystick.

When carrying out point measurements, it is essential to ensure that the laser spot lines up with the cross hairs. If this is not the case, the tool must be recalibrated by the Hilti repair service.

The “Measure and record” application can be started by pressing the corresponding button in the application menu.

10.2.2 Procedure for application “Measure and record”

To start the application “Measure and record”, press the button **Meas & Rec** in the main menu.

1. Start “Measure & record” dialog

- Selecting a project
- Station definition and station setup

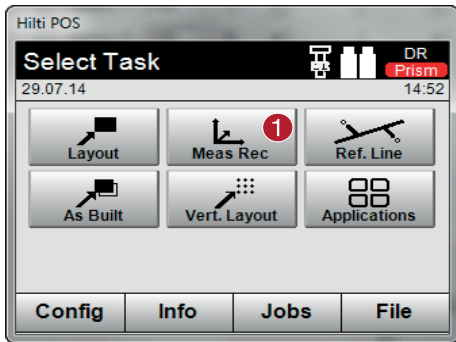

- ① Selecting the application “Measure and record”

2. “Measuring point” measuring dialog

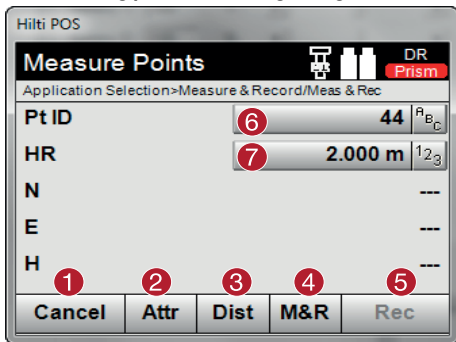

- ① Cancel and return to previous screen
- ② Entry and display of the attributes for the corresponding measuring point. Entry of up to five different attributes per measuring point
- ③ Measure individual distance
- ④ Measure distances and angles at the touch of a button and save data at the same time
- ⑤ Following valid distance measurement, angles are measured and the distance is then saved together with the angle.
- ⑥ Entry of the alphanumerical point designation
- ⑦ Entry of the reflector height (if the station has been set up with heights)

Saving data in memory with “Measure and record”

NOTE

The points measured can be assigned various point designations and saved in memory. Each time a point is saved, the number assigned to the name of the point is raised by “1”. The point data saved in memory can be transferred to a PC for further use in a CAD or similar system or printed out for documentation and archival purposes. If the option to exclude heights is activated when setting up the station, height values and all associated information, such as reflector height, are not displayed.

Saving data in memory with “Measure and record”

Point number	Name and designation of the measuring point
Northings (specified)	Measured northings
Eastings (specified)	Measured eastings
Height (specified)	Measured height
Eastings (measured)	Applied atmospheric correction (ppm)
Attribute 1 - Attribute 5	Attributes assigned to the point

10.3 Reference line

The reference line application is an application that deals with the handling of lines and curves. The reference line application can be used to calculate and set out control lines using coordinates, to record control lines marked on the construction site and to move lines in a defined way. In addition, points with longitudinal and lateral dimensions with reference to the defined control line can be set out directly.

This is particularly easy when the control line is previously defined as a graphical line or curve using coordinates. The lines and curves can then be selected by the press of a finger without having to re-enter the lines or curves again when changes are made.

10.3.1 Principle of the reference line

Control line definition

Methods for defining the control line for lines and curves

- Line (2 points)
- Curve (2 points + radius)
- Curve (3 points)

en

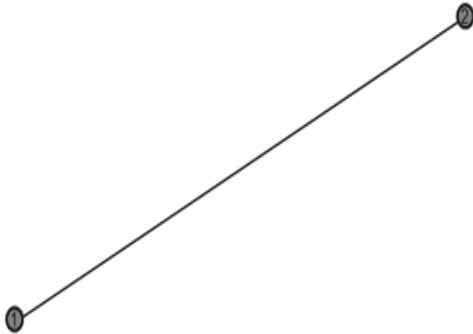

NOTE

If the line or curve items are defined with points at different heights, the height is interpolated accordingly, depending on the longitudinal value.

Moving the control line

According to the control line definition, the control line can still be moved in three directions and can be rotated once.

Moving and rotating the control line

- Moving in the longitudinal direction
- Moving in the lateral direction
- Changing the height
- Rotating around the starting point

Control line measuring options

The control line measurements can be divided into two different applications:

Applications for measuring the control line

- **Layout (longitudinal and lateral dimensions)**
Set out the points using entered line dimensions (longitudinal and lateral) in relation to the control line.
- **Survey (distance of point to control line)**
Measure points and display dimension (longitudinal and lateral) in relation to the control line.

Depending on the selected function, the longitudinal and lateral values can be entered or measured.

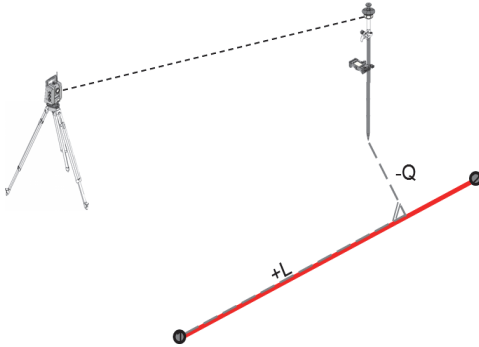

10.3.2 Reference line with prism

In this procedure, the EDM is set to “Prism”.

Setting out with the prism corresponds to navigation to the layout position.

Layout with entered longitudinal and lateral values is the same as for the “Horizontal layout” application.

10.3.2.1 Procedure for application “Reference line with prism”

To start the “Reference line” application, press the button **Ref. Line** in the main menu.

1. Start “Reference line” dialog

- Selecting a project
- Station definition and station setup

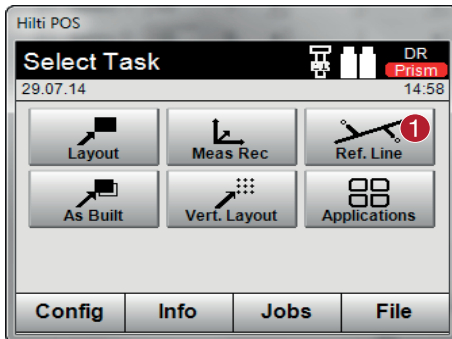

- ① Select “Reference line” application

2. “Control line definition” entry dialog

Control lines can be defined in three different ways for lines and curves:

- Graphically from a digital plan by “tapping”
- Using coordinates - entering or selecting coordinates from a coordinate list
- By measuring to two available axis points on the construction site

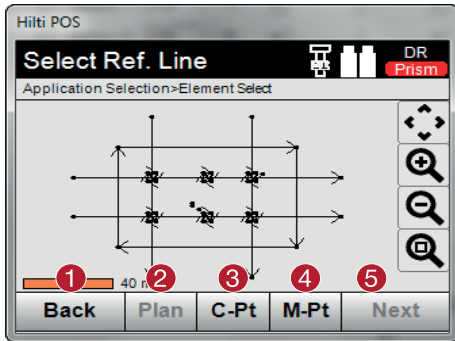

- ① Return to previous dialog
- ② Definition and selection of control line from drawing
- ③ Definition of control line from coordinate list
- ④ Definition of control line from point measurement
- ⑤ If the control line has been defined, continue to displacement dialog

3. "Displacements" entry dialog

- Entry of the longitudinal, lateral and height displacements including angle of rotation

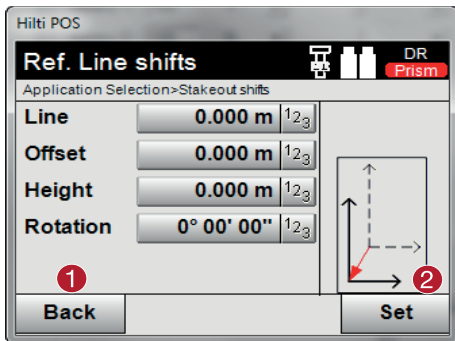

- ① Return to control line definition
- ② Confirm the displacement entries. Continue with entry dialog for longitudinal, lateral and height values.

Setting: Setting out longitudinal and lateral dimensions

"Longitudinal / lateral" entry dialog

- Entry of the longitudinal, lateral and height displacements including angle of rotation

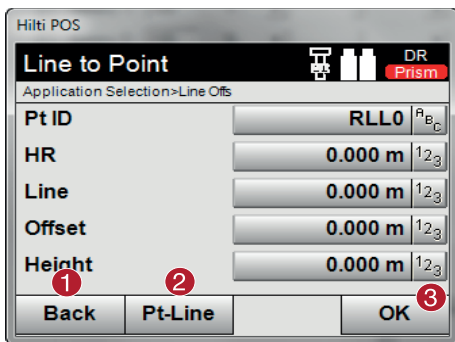

- ① Return to displacement dialog
- ② Change to the survey setting (distance of point to control line)
- ③ Confirm entry values

NOTE

The dialog sequence beyond this point is the same as for the "Horizontal layout" application; the layout values are displayed and the layout differences and control line values are saved.

Setting: Survey (distance of point to control line)
 Measuring dialog with “Longitudinal / lateral” display

- Point measurement with display of calculated longitudinal and lateral values

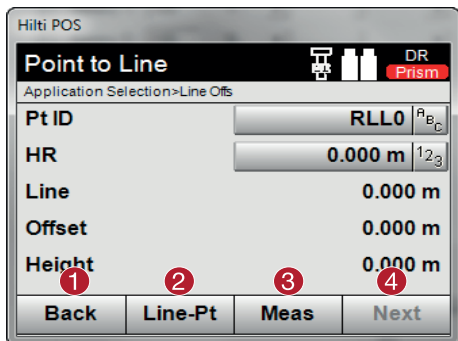

- ① Return to displacement dialog
- ② Change to layout setting for longitudinal and lateral values
- ③ Take the measurement
- ④ Save the displayed values

en

10.3.3 Reference line with visible laser (laser pointer)

In this procedure, the EDM is set to “Laser ON”. This ensures that for practical setting out with the “red dot”, the layout point is directly selected and the layout position virtually marked with the red dot. As the red laser is more easily seen in lower ambient light, this application is primarily used indoors.

To enable the layout point to be directly selected in three dimensions, the station must be set up with the height values specified.

It is, however, also possible to set out using floors or ceilings without specification of heights. The the laser must first be trained onto the area. In this case, the software attempts to find the point position or the corresponding plumbline on the area in question.

NOTE

The “Layout” application with the “red” laser is suitable for layouts on floors and ceilings. The application is not suitable for layouts on the wall.

NOTE

The procedure from this point is the same as for the prism. The layout and measuring process can be compared with the description for horizontal layouts.

10.3.4 Saving layout data

Point number	Name of layout point
Northings (specified)	The northings entered refer to the coordinate reference system.
Eastings (specified)	The eastings entered refer to the coordinate reference system
Height (specified)	Specified heights
Northings (measured)	Measured northings refer to the coordinate reference system
Eastings (measured)	Measured eastings refer to the coordinate reference system
Height (measured)	Measured height
dN	dN = Northings (measured) – Northings (entered)
dE	dE = Eastings (measured) – Eastings (entered)
dH	dH = Height (measured) – Height (entered)

10.4 As-built

10.4.1 The principle of "As-built"

In principle, as-built measurements can be regarded as a reversal of the horizontal layout application.

With as-built, existing positions are compared with their positions on the plan and the deviations shown and recorded accordingly.

Depending on how the station has been set up, the plan data or, respectively, the positions to be compared, can take the form of dimensions, coordinates or points in graphics.

If plan data in the form of CAD drawings can be transferred from a PC to the total station and the applicable graphical points then selected from the display of the tool, there is no longer any need to work with long numbers or lots of numbers.

Typical applications are checking walls, columns, formwork, large openings and much more. These jobs are done by comparing positions on the plan with actual points on the object and displaying or, respectively, recording the differences.

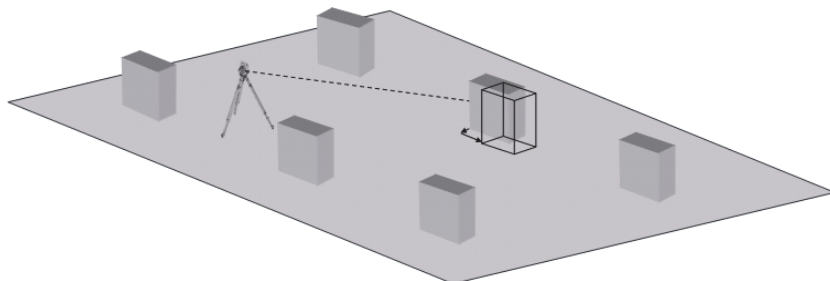

To start the "As-built" application, select the corresponding button in the application menu. After starting the application, the projects or list of projects is shown for selection as well as the corresponding station selection or station setup. The "As-built" application begins after station setup is completed.

NOTE

Deviations from the given and the measured position can be saved and output as a report in Hilti PROFIS Layout.

10.4.2 As-built with prism

To measure points as built, the position is first defined with an entry.

Entering an as-built point

Options for entering the point coordinates

- Manual entry of point coordinates.
- Selection of point coordinates from a list of points saved in memory.
- Selection of point coordinates from a CAD drawing with points saved in memory.

A very efficient way is to enter the as-built position from the saved drawing in the tool, from which the corresponding two-dimensional or three-dimensional data is extracted.

10.4.2.1 Procedure for application "As-built with prism"

1. "As-built" starting dialog

To start the "As-built" application, press the button **As-built** in the main menu.

Procedure

1. Selecting a project
2. Station definition and station setup

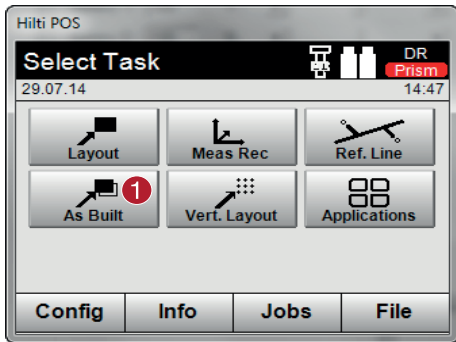

- ① Select "As-built" application

2. "As-built" entry dialog

Options for determining the point coordinates for as-built points

- Enter manually
- Select from a list of saved points
- Select from a CAD drawing with saved points

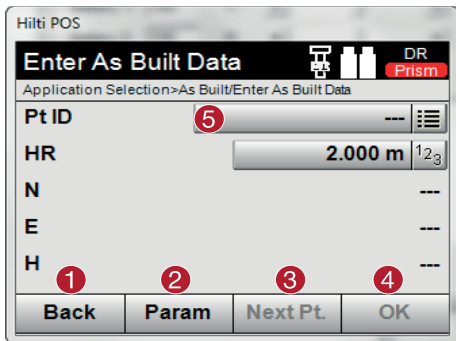

- ① Return to previous dialog 4. Confirm dialog 5. Select points
- ② Enter the layout settings. Sorting criteria for automatic point suggestion, automatic point tracking (on/off), layout tolerances, measuring delay, in order to align the prism rod sufficiently before the distance measurement
- ③ Select the next point if automatic point suggestion is selected in the settings
- ④ Confirm dialog
- ⑤ 5. Select points

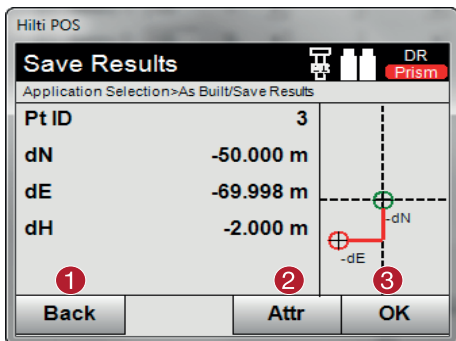

- ① Return to previous dialog
- ② Entry and display of the attributes assigned to the point
- ③ Confirm dialog and save data

NOTE

If the option to exclude heights is activated when setting up the station, height values and all associated information are not displayed.

Saving layout data

Point number	Name of the point to be measured
Northings (specified)	Specified northings
Eastings (specified)	Specified eastings
Height (specified)	Specified heights
Northings (measured)	Measured northings
Eastings (measured)	Measured eastings
Height (measured)	Measured height
dN	dN = Northings (measured) – Northings (entered)
dE	dE = Eastings (measured) – Eastings (entered)
dH	dH = Height (measured) – Height (entered)
Attribute 1 – Attribute 5	Attributes assigned to the point

NOTE

Attributes are descriptions of the point and can be taken together with the point coordinates directly from AutoCad or Revit using Hilti Point Creator or can be entered manually

For Hilti products such as anchors, rails, etc., the item numbers, description, layer, type of graphical element and color are taken from AutoCad or Revit. The CAD data can contain 2D or 3D data and attributes (but does not have to).

10.5 Exchanging data with a PC for “Layout” and “Measure & Record”

10.5.1 Procedure with the PROFIS Connect application

NOTE

Version 2.2.0 and higher of the total station application software also includes the PROFIS Connect application. If the version number of your total station application software is lower than 2.2.0, please contact your Hilti representative.

The “PROFIS Connect” application lets you record and lay out points through dynamic exchange of coordinates with a design application installed on a PC connected to the total station. The coordinates of newly measured points can be transferred from the total station to the design application and existing point coordinates can be transferred from the design application to the total station.

1. PROFIS Connect start dialog

- To start the “PROFIS Connect” application, simply click “PROFIS Connect” in the main menu.

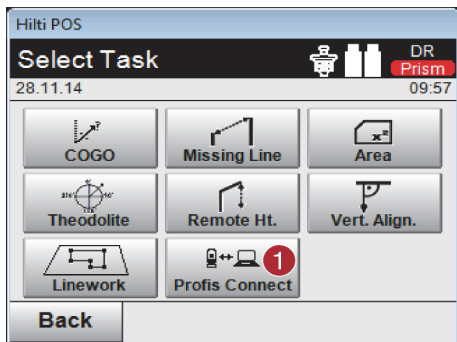

- Activating data exchange with Hilti PROFIS Connect

2. Selecting the application to be used for data exchange

- Select the application for which you wish to activate data exchange.

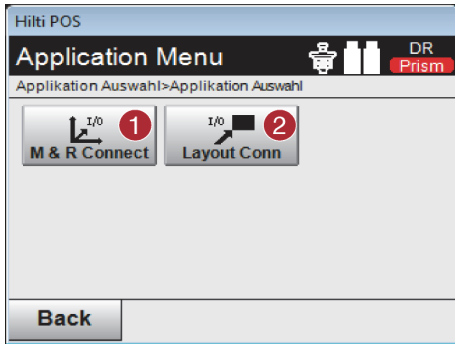

- ① Start the “Measure & Record” application with data exchange. Points are transferred from the total station to the design application on the PC.
- ② Start the “Layout” application with data exchange. Points are transferred from the design application on the PC to the total station.

en

10.6 Vertical layout (Vert. layout)

10.6.1 The vertical layout principle

In a vertical layout, plan data is transferred to a vertical reference plane such as a wall or facade, etc.

This plan data is either in the form of dimensions that relate to the building control line in the vertical reference plane or positions described by coordinates in a vertical reference plane.

The plan data or layout positions in the form of dimensions or distances can be entered with coordinates or can be transferred previously from a PC.

In addition, plan data in the form of CAD drawings can be transferred to the total station and the applicable graphical points for the layout then selected from the display of the tool.

This makes working with long numbers or lots of numbers unnecessary.

Typical applications are the positioning of fastening points on facades, installation channels on walls, pipes, etc.

A special application offers the possibility of comparing a vertical surface with a theoretically absolutely flat surface in order to check for unevenness or, respectively, to produce a record of the results.

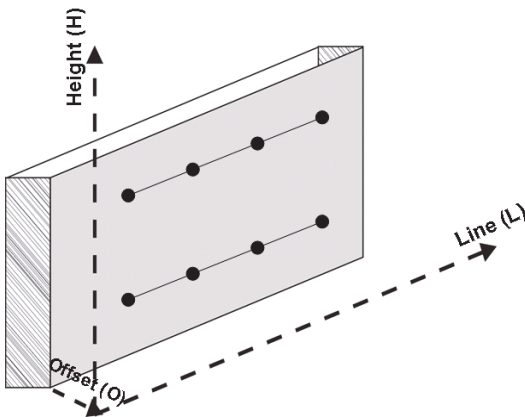

The “Vertical layout” application can be started with the corresponding button in the in the application menu.

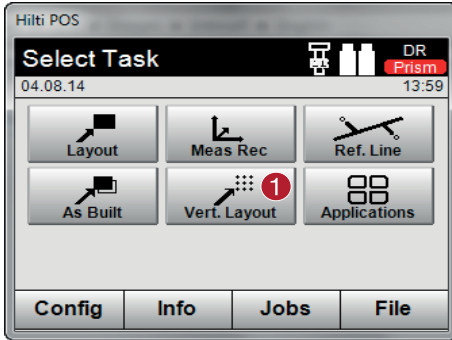

① Select the vertical layout application

After starting the application, the projects or list of projects is shown for selection as well as the corresponding station selection or station setup.

The "Vertical layout" application begins after station setup is completed.

Depending on the station selected, there are two alternative methods for determining the point to be laid out:

1. Laying out points with building control lines, i.e. control lines in the vertical reference plane.
2. Laying out points with coordinates or points based on a CAD drawing

10.6.2 Vertical layout with building control lines

In a vertical layout with building control lines the control lines are defined by measuring to two reference points when the station is set up.

Setting up the station

The station should be set up in front of the vertical plane in a position that is as central as possible and at a distance that allows as clear a view as possible of all points.

The zero point **(1)** of the reference axis system and the direction **(2)** of the vertical reference plane are defined when the tool is set up.

Caution

The reference point **(1)** is the decisive point. The vertical and horizontal reference axes in the vertical reference plane are set on this point.

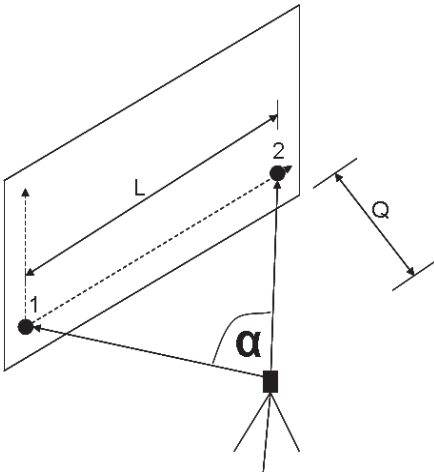

An optimum setup or, respectively, tool position has been achieved when the ratio between the horizontal reference length **L** and the distance **Q** is $L : Q = 25 : 10$ to $7 : 10$, so that the included angle lies between $\alpha = 40^\circ - 100^\circ$.

NOTE

The procedure for setting up the station is the same as for setting up the station “anywhere” with building control lines, with the difference that the first reference point is set at the zero point of the building control line system in the vertical plane and the second reference point defines the direction of the vertical plane relative to the tool system. In any case, the horizontal and vertical control lines are adopted from point (1).

Shifting a control line

In order to shift the control line system or, respectively, the “zero point” on the vertical reference plane, shift values require to be entered.

These shift values can be used to shift the zero point of the control line system to the left (-) and right (+) horizontally, up (+) and down (-) vertically, and the entire plane forwards (+) and backwards (-).

It can be necessary to shift a control line when the “zero point” cannot be sighted directly as the first reference point. An existing reference point than has to be used and then shifted onto a control line by entering the applicable shift values (distances).

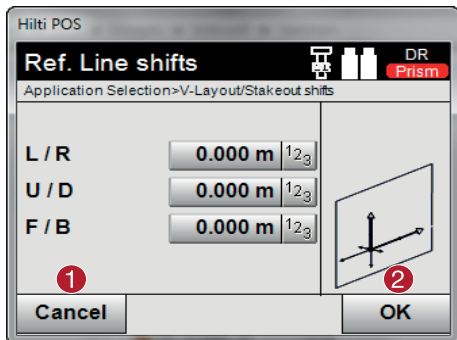

- ① Return to control line definition
- ② Confirm the displacement entries. Continue with entry dialog for longitudinal, lateral and height values.

Entering a layout position

The layout value is entered as a dimension relative to the reference axis or building control line in the vertical plane that was defined when the station was set up.

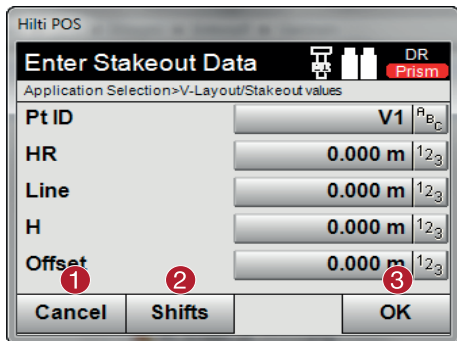

- ① Cancel and return to the start menu
- ② Enter reference plane shifts
- ③ Confirm entry and continue, showing display for aligning the tool with the point to be laid out

Direction to the layout point

Using this screen, the tool is aimed at the point to be laid out by rotating the tool until the red direction indicator shows “zero”.

The cross hairs are then aimed in the direction of the point to be laid out.

The telescope can then be moved vertically until both triangles are shown as unfilled outlines.

NOTE

If the upper triangle is solid - move the telescope downwards. If the upper triangle is solid - move the telescope downwards.

Where possible, the person holding the rod can move into position on the sighting line with the aid of the guide light.

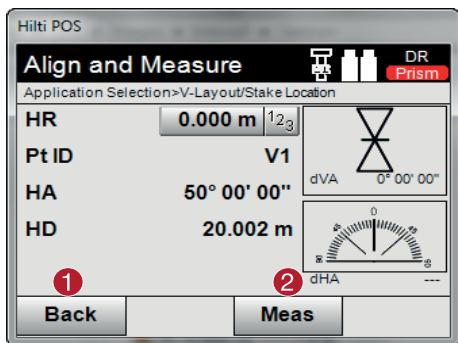

- ① Return to entry of layout values
- ② Measure distance and continue, showing layout corrections

Layout corrections

Using the corrections displayed, the target bearer or target is guided **Up, Down, Left, Right** into position.

With the aid of distance measurement, a correction **Forward** or **Back** can also be made.

The corrections shown are updated after each distance measurement until, step by step, the final position is reached.

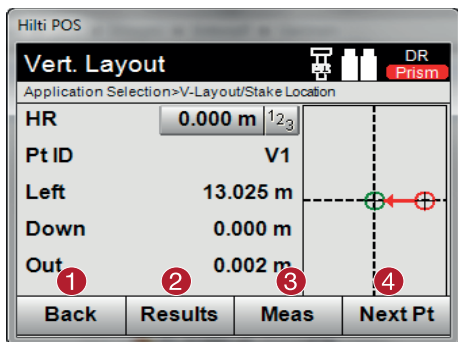

- ① Return to entry of layout values
- ② Show and save the result
- ③ Measure distance and update layout corrections
- ④ Enter the next point

Instructions displayed concerning movement of the target to which measurements are taken.

Fwd	The target must be moved further toward the reference plane.
Back	The target must be moved further away from the reference plane.
Left	The target must be moved further to the left, as seen from the tool, by the amount indicated.
Right	The target must be moved further to the right, as seen from the tool, by the amount indicated.
Up	The target must be moved further up, as seen from the tool, by the amount indicated.
Down	The target must be moved further down, as seen from the tool, by the amount indicated.

Layout results

Shows the layout difference in terms of length, height and offset based on the last distance and angle measurements.

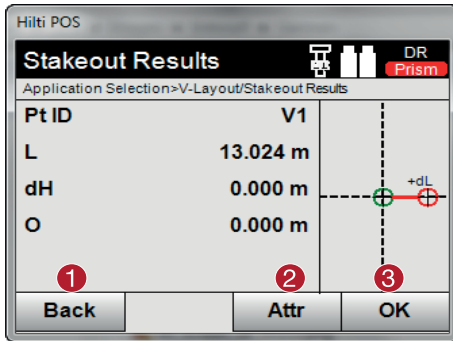

- ① Return to entry of layout values
- ② Enter attribute values
- ③ Confirm

en

Saving data for staking out with building control lines

Pt ID	Name of layout point.
Line (entered)	Line distance entered, relative to the reference axis.
Height (entered)	Height entered.
Offset (entered)	Vertical offset entered, relative to the reference plane.
Line distance (measured)	Line distance measured, relative to the reference axis.
Height (measured)	Measured height.
Offset (measured)	Offset measured relative to the reference plane.
dL	Difference in line value based on the reference axis. dL = line (measured) – line (entered)
dH	Difference in height. dH = height (measured) – height (entered)
dOffs	Difference in offset value based on the reference axis. dO = offset (measured) – offset (entered)

10.6.3 Vertical layout with coordinates

Coordinates can be used, for example, when coordinates are available as reference points and points in the vertical plane are also available as coordinates in the same system.

This is the case, for example, when points in the vertical plane have been measured previously using coordinates.

Entering the layout points

Three different methods can be used to enter layout values with point coordinates:

1. Manual entry of point coordinates.
2. Selection of point coordinates from a list of points saved in memory.
3. Selection of point coordinates from a CAD drawing with points saved in memory.

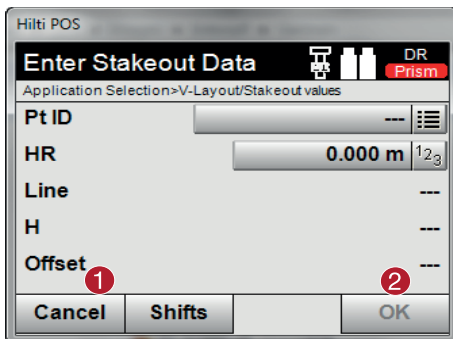

- ① Cancel and return to the start menu
- ② Confirm entry and continue, showing display for aligning the tool with the point to be laid out

Entering the layout values (from a CAD drawing)

With this method the layout points are selected directly from CAD graphics.

With this method, the point is already incorporated in the drawing as a three-dimensional or two-dimensional point and can be extracted accordingly.

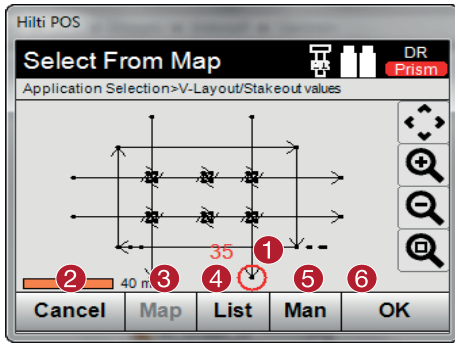

- ① Shows the point selected from the graphical display
- ② Return to entry of layout values
- ③ Select a point from a plan
- ④ Select a point from a list
- ⑤ Enter coordinates manually
- ⑥ Confirm the selected point

Layout results with coordinates

Shows the layout difference in terms of coordinates based on the last distance and angle measurements.

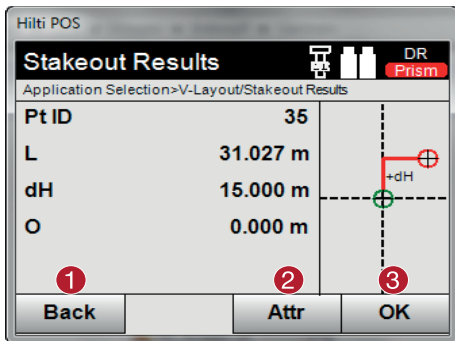

- ① Return to entry of layout values
- ② Enter attribute values
- ③ Confirm

Saving data for staking out with coordinates

Pt ID	Name of layout point.
Northings (entered)	The northings entered refer to the coordinate reference system.
Height (entered)	Height entered.
Eastings (entered)	The eastings entered refer to the coordinate reference system.
Northings (measured)	Measured northings refer to the coordinate reference system.
Height (measured)	Measured height.
Eastings (measured)	Measured eastings refer to the coordinate reference system.
dN	Difference in northing based on the coordinate reference system. dN = delta north (measured) - delta north (entered)

dH	Difference in height. $dH = \text{height (measured)} - \text{height (entered)}$
dE	Difference in coordinate easting based on the coordinate reference system. $dE = \text{delta east (measured)} - \text{delta east (entered)}$

NOTE

The vertical layout always uses three-dimensional point descriptions. In layouts with control lines and layouts with coordinates, the line, height and offset dimensions are used.

NOTE

The other screens shown are the same as described in the previous section.

10.7 CoGo (Coordinate Geometry)

To start the “CoGo” application, press the “CoGo” button in the main menu. After starting the application, the following calculation programs are available for use:

- Inverse
- Offsets
- Intersection
- Angle
- Point in direction
- Area

10.7.1 Overview

With the aid of CoGo's, calculations can be carried out in the field.

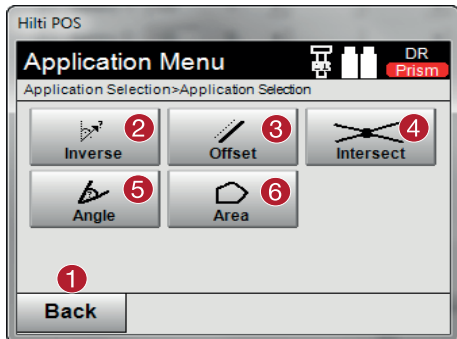
1. Select CoGo calculation program

- ① Return to previous dialog
- ② Inverse: Calculation of azimuths and line segments
- ③ Offset: Calculation of offset points
- ④ Intersection: Calculation of intersections
- ⑤ Angle: Calculation of angles
- ⑥ Area: Calculation of area

NOTE

No connection with the total station is required for use of the CoGo functions.

The following calculations can be carried out with the aid of these applications:

- Inverse: Calculation of the azimuth, distance, line and offset, and height difference from given points or elements.
- Offsets: Calculation of offset points
- Intersection: Calculation of the intersection of elements
- Angle: Calculation of the angle between elements
- Area: Calculation of area

The calculation is based on

- existing points in a job, known distances or known azimuths
- measured points
- the coordinates entered

10.7.2 Inverse

The following options are available for the calculation.

- 2 points: Azimuth and distance are calculated.
- Line / curve elements: The azimuth and line / curve length are calculated.
- Line / curve element and point: The line / curve length and offset are calculated.

1. Select CoGo “Inverse”

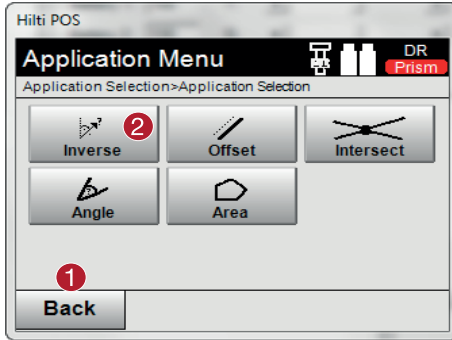

- ① Return to previous dialog
- ② Calculation of azimuths, line segments and height differences

2. Select the elements

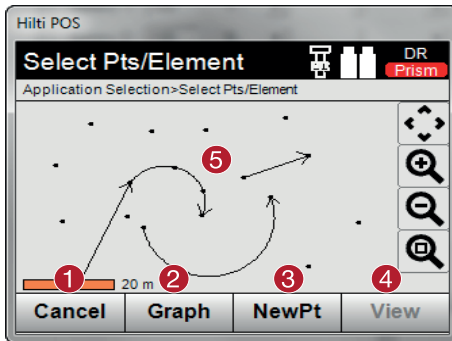

- ① Return to previous dialog
- ② Create a new element
- ③ Create a new point
- ④ Display the result
- ⑤ Select the element

In order to start the calculation:

- two points or
- one line or curve or
- one line / curve and a point

have to be selected.

The calculation can then be started with ④.

3. Result

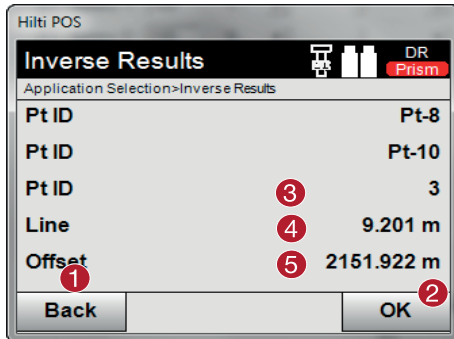

- ① Return to previous dialog
- ② Confirm dialog
- ③ Display the azimuth
- ④ Display line segment / arc length, distance between points
- ⑤ Display height difference, if available

en

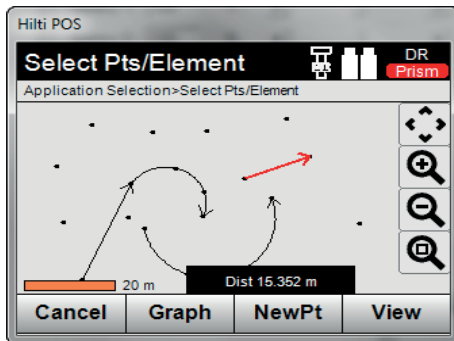
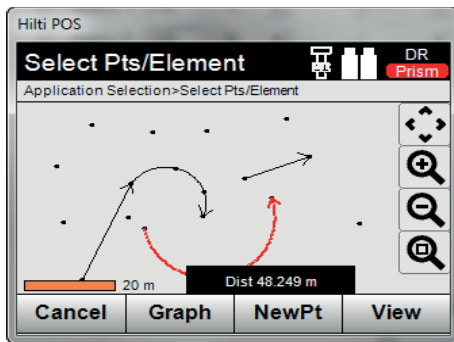

en

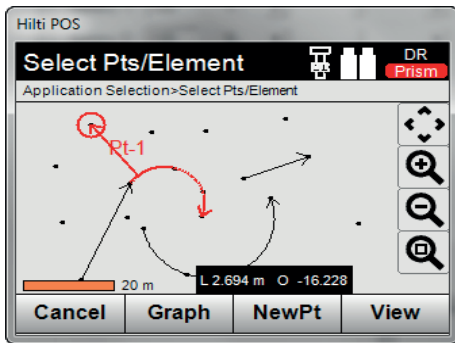
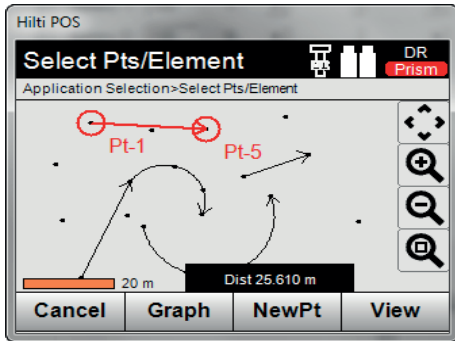

10.7.3 Offset

Points along lines and curves can be calculated with the aid of the Offset function.

In order to start the calculation:

- one line or
- one curve

have to be selected.

1. Select CoGo "Offset"

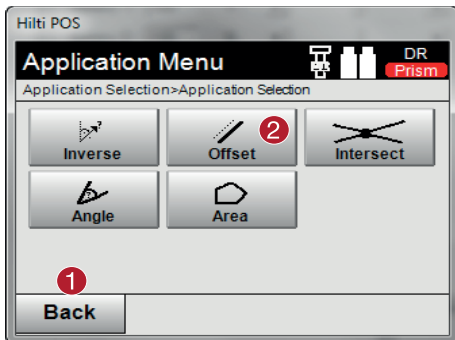

① Return to previous dialog

② Calculation of offsets

2. Select the element

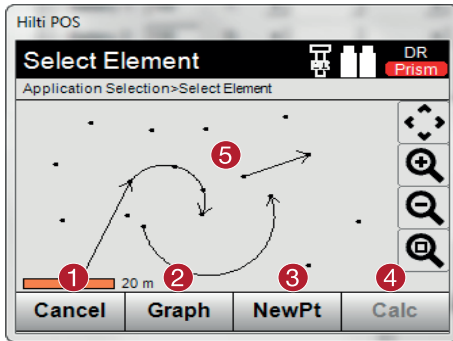

In order to start the calculation:

- one line or
- one curve

have to be selected.

The calculation can then be started with .

- ① Return to previous dialog
- ② Create a new element
- ③ Create a new point
- ④ Start the calculation
- ⑤ Select the element

en

3. Define the offsets

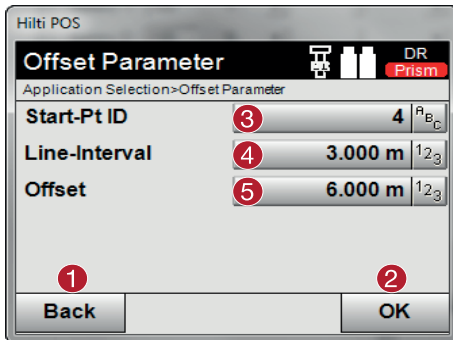

- ① Return to previous dialog
- ② Confirm dialog
- ③ Select starting point
- ④ Enter the interval
- ⑤ Enter the offset

4. The result is shown

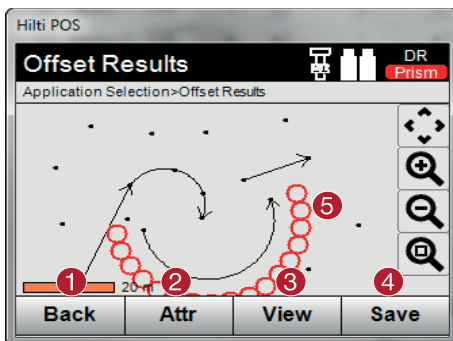

- ① Return to previous dialog
- ② Display attributes
- ③ Display the new points
- ④ Save the new points
- ⑤ Elements with offset points

10.7.4 Intersection

The intersection of 2 elements can be calculated with the aid of the Intersection function.

In order to start the calculation:

- two lines or
- one line and a curve or
- two curves

have to be selected.

1. Select CoGo “Intersection”

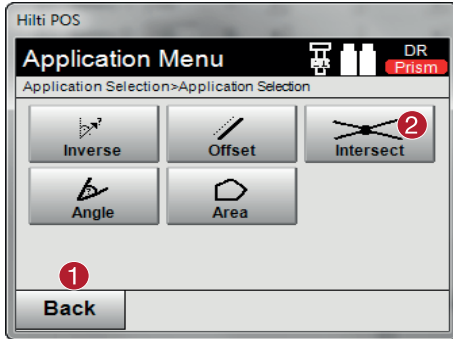

- ① Return to previous dialog
- ② Calculate intersection

2. Select the elements

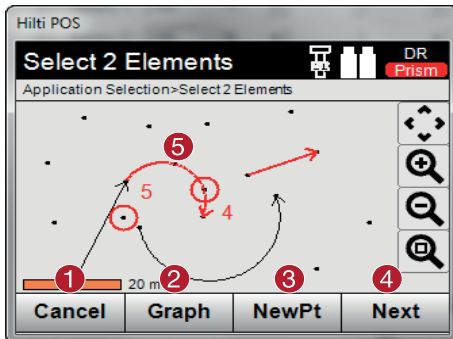

- ① Return to previous dialog
- ② Create a new element
- ③ Create a new point
- ④ Start the calculation
- ⑤ Select the elements

In order to start the calculation:

- two lines or
- one line and a curve or
- two curves

have to be selected.

The calculation can then be started with \oplus .

3. Define the name for the new points

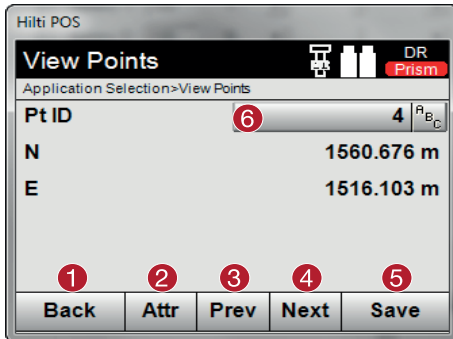

- ① Return to previous dialog
- ② Display attributes
- ③ Display previous points
- ④ Display the next point
- ⑤ Save point(s)
- ⑥ Define point name

en

4. The result is shown

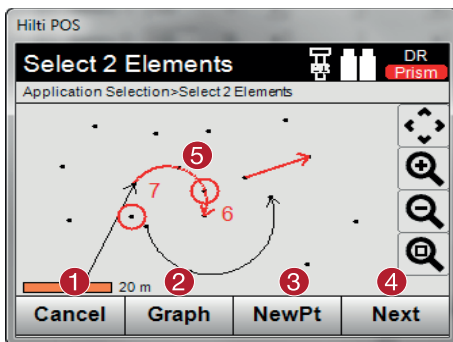

- ① Return to previous dialog
- ② Create a new element
- ③ Create a new point
- ④ Display the next point
- ⑤ Calculated intersection

10.7.5 Angle

The angle between 2 elements can be calculated with the aid of the angle function. In order to start the calculation, 3 points must be selected:

1. Select CoGo "Angle"

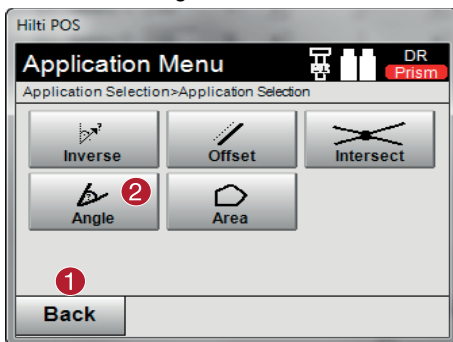

- ① Return to previous dialog
- ② Calculate angle

2. Select points

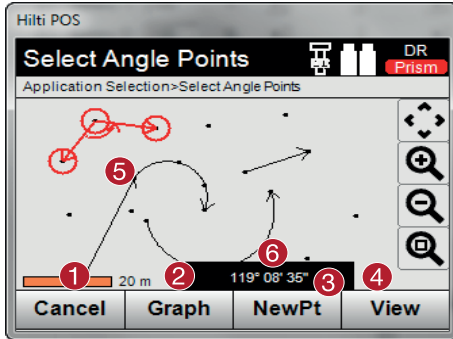

- ① Return to previous dialog
- ② Create a new element
- ③ Create a new point
- ④ Start the calculation
- ⑤ Select the 3 points
- ⑥ Display the current angle

In order to start the calculation, 3 points must be selected:
The calculation can then be started with ④.

3. The result is shown

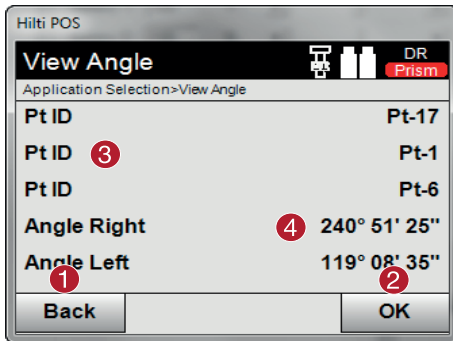

- ① Return to previous dialog
- ② Confirm dialog
- ③ Display the points
- ④ Display the angle

10.7.6 Calculate area

The area can be calculated with the aid of the area function.
In order to start the calculation at least 3 points (a maximum of 99 points) must be selected.
The line is closed automatically when the area calculation is started.

1. Select CoGo "Area"

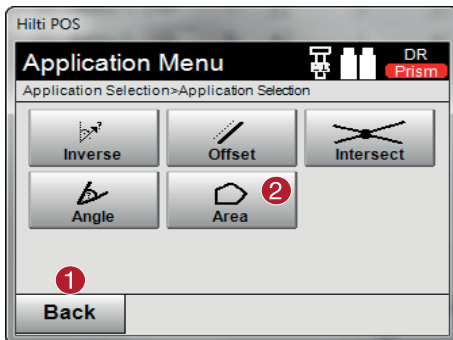

- ① Return to previous dialog
- ② Calculate area

2. Select the element

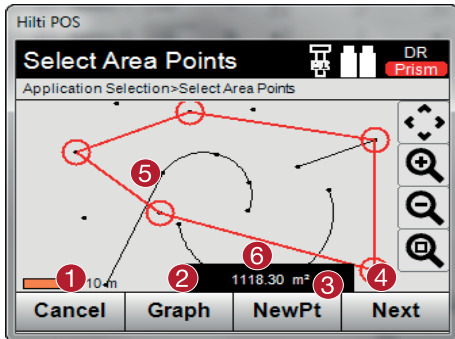

The calculation can then be started with **④**.
A point already selected can be deleted by clicking on it again.

3. The result is shown

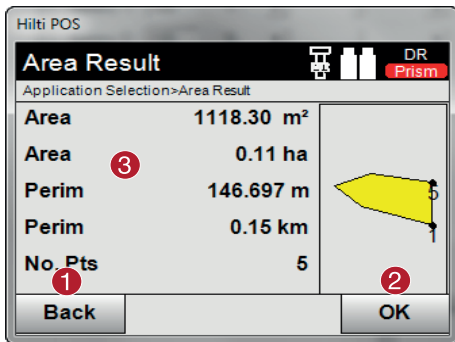

10.8 Missing line

10.8.1 The principle of "Missing line"

With the "Missing line" application, two points anywhere within a certain space can be measured in order to determine the horizontal distance, slope distance, height difference and slope or angle between the points.

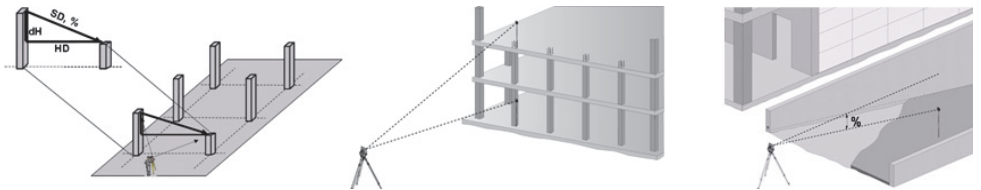

Two different methods can be used to determine the missing line:

- Using the results of measurements to the first and all other measured points
- Using the results of measurements to two points

1. Radial “missing line” in relation to reference point

en

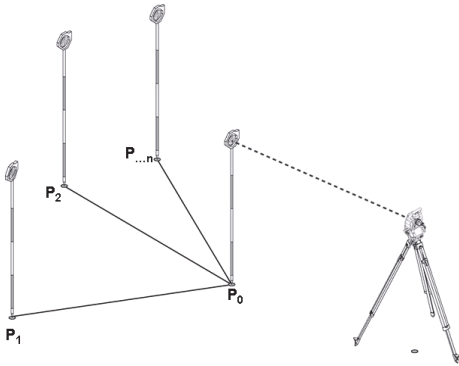

After measuring the first point, all other points measured relate to this first point.

2. Linear “missing line” in relation to first and second point

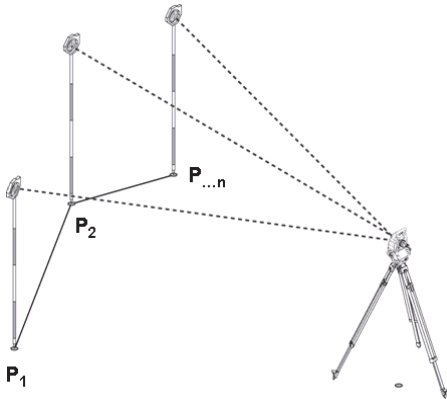

Measure the first two points.

After obtaining the result, choose a new line and measure the new first point and the new second point.

10.8.2 Procedure for “missing line” application

To start the “Missing line” application, press the **Missing line** button in the main menu.

1. "Missing line" starting dialog

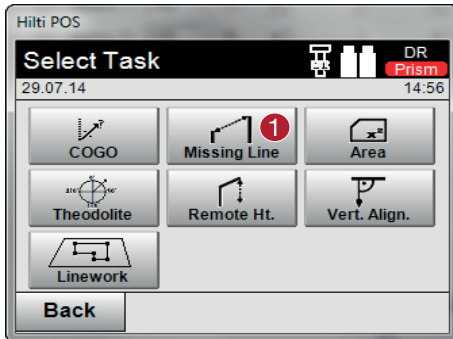

- ① Select missing line application

en

2. "Measuring point 1" measuring dialog

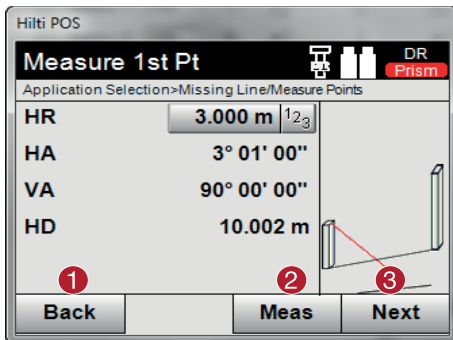

- ① Return to project dialog
- ② Initiate measurement
- ③ Continue to next dialog after measurement

3. "Measuring point 2" measuring dialog

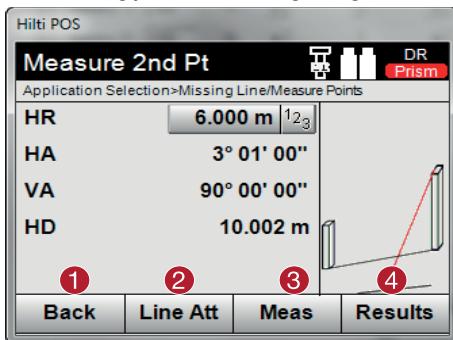

- ① Back
- ② Entry and display of the attributes assigned to the point
- ③ Initiate measurement
- ④ Display results

NOTE

With **radial missing line**, measurement of each additional point (P_n) always relates to the first point (P_0). In the case of the **linear "missing line"** each new measurement (P_n) relates to the last measured point (P_{n-1}).

Displaying the results and saving data for the "missing line"

Slope distance	Slope distance between the two last measuring points
Horizontal distance	Horizontal distance between the two last measuring points

Difference in height	Difference in height between the two last measuring points
Inclination %	Inclination in percent (%)
Inclination angle %	Angular inclination of the system setting

en

10.9 Area measurement

10.9.1 The principle of area measurement

The tool can calculate the horizontal or vertical area enclosed by a total of up to 99 consecutively measured points. The points can be measured in a clockwise or counterclockwise sequence.

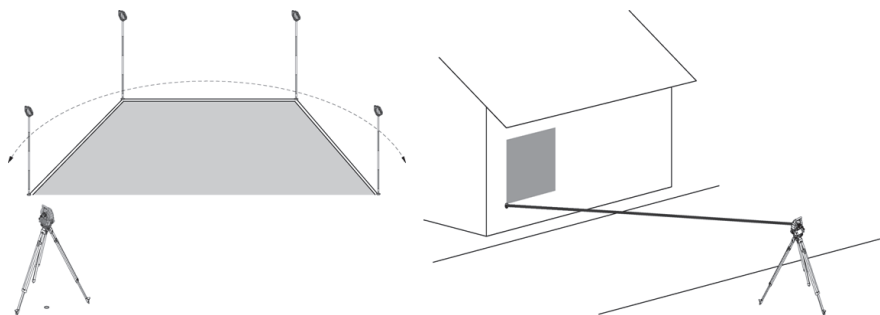

NOTE

The points must be measured in such a way that the lines between the measured points do not cross each other, otherwise an incorrect area measurement will result.

NOTE

The station does not have to be set for this application.

The horizontal area is calculated by projecting the measured points in the horizontal plane.

The points must be measured in a sequence that encloses an area.

For the calculation, enclosure of the area is always completed by an imaginary line between the last measured point and the first measured point.

10.9.2 Procedure for area measurement application

To start the application "Area measurement", press the button **Area measurement** in the main menu.

1. "Area measurement" starting dialog

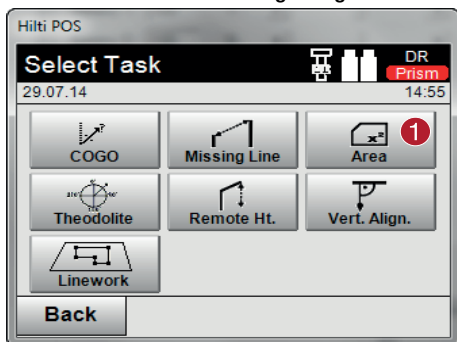

- ① Select area measurement application

2. "Measuring point" measuring dialog

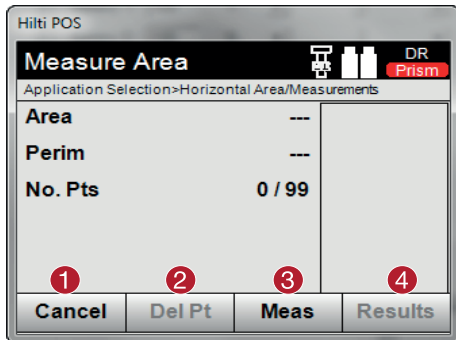

- ① Return to project selection
- ② Delete the last measured point
- ③ Initiate measurement to point
- ④ Show the result of area measurement

en

Results

The results are saved in internal memory and can be displayed on a PC or printed out using Hilti PROFIS Layout.

10.9.3 Saving data for area measurement

Saving data for area measurement

Area	Area in basic units, e.g. m ² , ft ² , etc.
Area	Area in large units, e.g. ha, acre etc.
Scope	Scope in basic units, e.g. m, ft, etc.
Scope	Scope in large units, e.g. km, miles, etc.
Number of measuring points	Number of points used to calculate the area

10.10 Theodolite

The theodolite application provides the basic theodolite functions for setting the horizontal circle for taking readings.

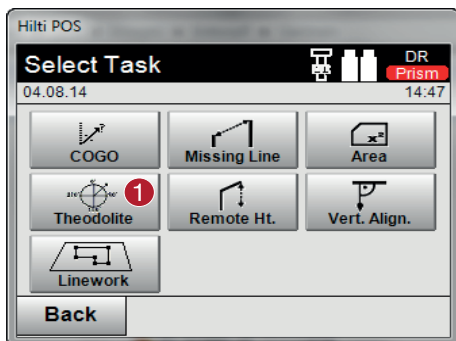

- ① Select the theodolite application

10.10.1 Zeroing the circle reading

The option Hz "Zero" can be used to zero the horizontal circle reading quickly and easily.

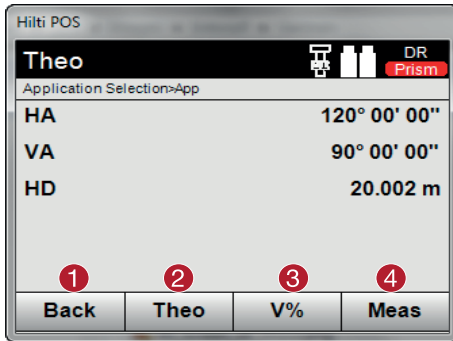

- ① Return to previous dialog
- ② Set station
- ③ Display the vertical angle in percent
- ④ Initiate measurement

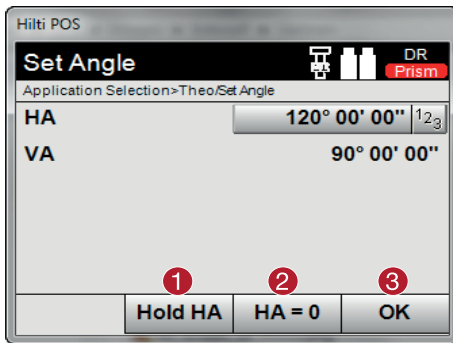

- ① Pause current horizontal circle reading
- ② Set current horizontal angle to 0
- ③ Confirm dialog



- ① Cancel and return to the previous screen without changing the horizontal value
- ② Set horizontal value to 0

10.10.2 Setting the horizontal circle display

The horizontal circle reading is held, the tool aimed at the new target and the circle reading then released.

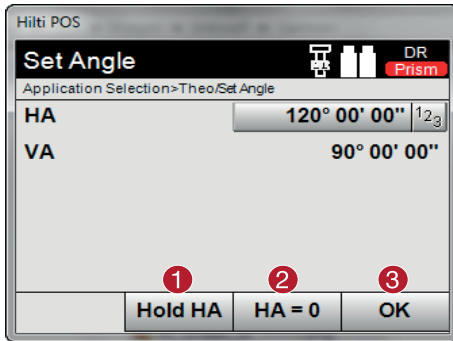

- ① Pause current horizontal circle reading
- ② Set current horizontal angle to 0
- ③ Confirm dialog

en

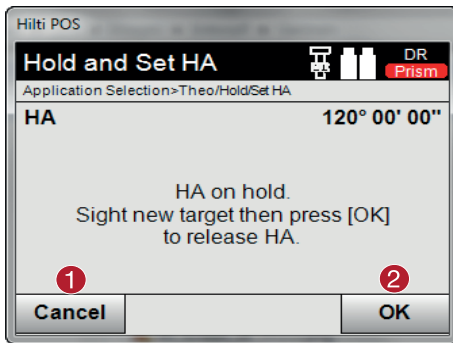

- ① Cancel and return to the previous screen without changing the horizontal value
- ② Set horizontal value in the display

10.10.3 Entering a circle reading manually

Any desired circle reading can be entered manually in any position.

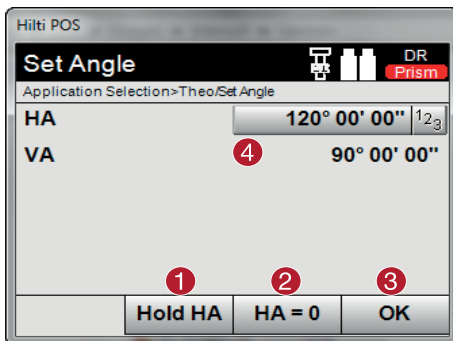

- ① Pause current horizontal circle reading
- ② Set current horizontal angle to 0
- ③ Confirm dialog
- ④ Enter the horizontal angle value manually

10.10.4 Inclination indicator 10

Readings from the vertical circle can be shown in the display in degrees or in percent.

NOTE

Readings can be shown in % only for this function.

This allows inclinations to be measured in % or objects aligned accordingly.

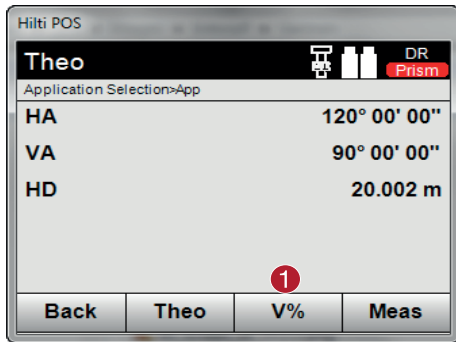

- ① Toggle vertical angle display between degrees and %

10.11 Indirect height measurement

10.11.1 The principle of indirect height measurement

The indirect height measurement method is used to determine the height difference to inaccessible objects or points in situations where direct distance measurement is not possible.

Virtually any height or depth, e.g. heights to the extremities of a crane, the depth of an excavation or heights in many other similar situations can be determined using the indirect height measurement method.

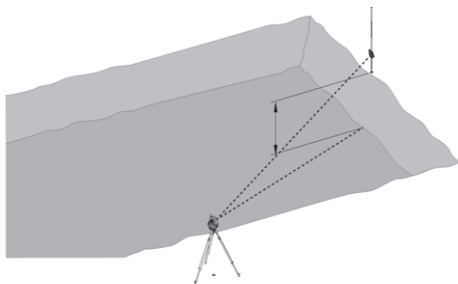
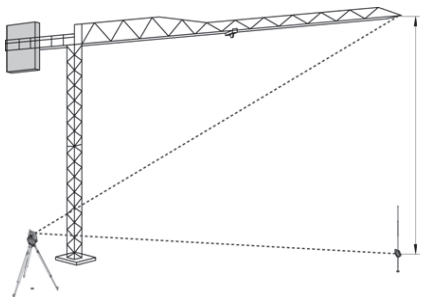

NOTE

It is essential that the reference point and the other inaccessible points all lie in the same vertical plane.

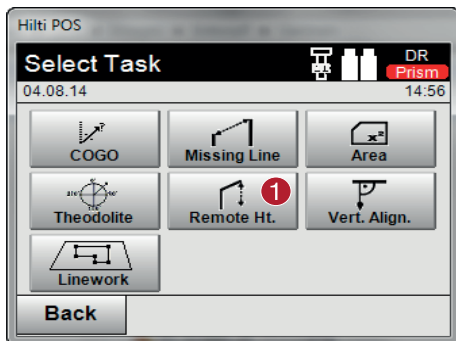

- ① Select the indirect height measurement application

After selecting the application the list of projects is displayed. The station does not have to be set for this application.

10.11.2 Indirect height measurement

Measurements to the 1st reference point

The angle and distance to the 1st reference point are measured.

The distance can be measured directly to the point or using the reflector rod, depending on ease of access to the 1st reference point.

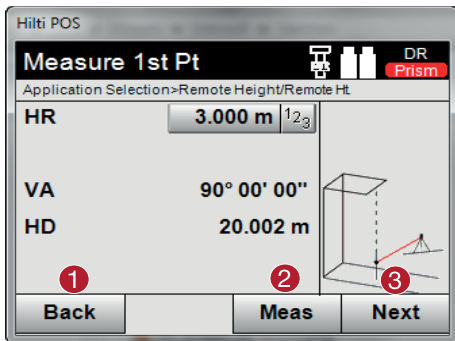

- ① Return to project selection
- ② Initiate measurement to point
- ③ Continue to the next measurement

en

Measuring to other points

Measuring to other points is carried out simply by measuring the vertical angles. The difference in height relative to the 1st reference point is indicated continuously.

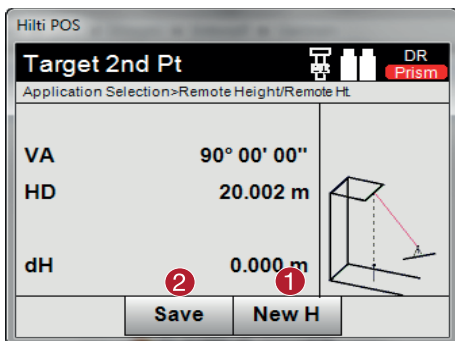

- ① New (additional) indirect height measurement based on a new reference point
- ② Save results

10.12 Vertical alignment

10.12.1 The principle of "Vertical alignment"

Vertical alignment can be used to check that objects are vertical or to transfer vertical lines.

We would like to point out the advantages of this system for setting up formwork for columns in the vertical plane or for laying out or checking points that lie vertically one above the other over several floors of a building.

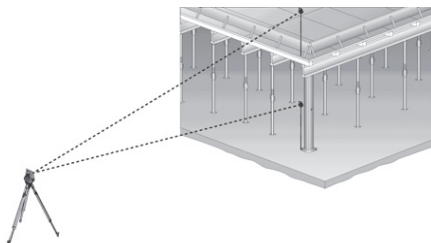
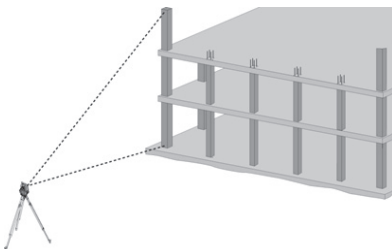

NOTE

In principle, two measured points are checked in order to determine whether they lie vertically one above the other.

NOTE

Depending on the needs of the application, the measurements can be made with or without use of a reflector rod.

en

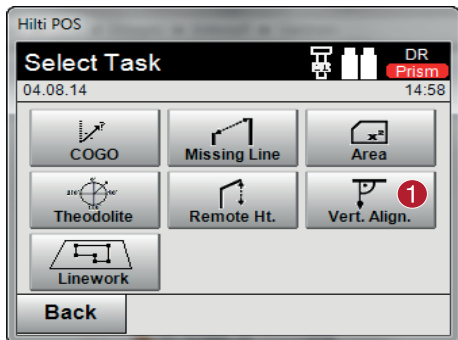

- ① Select the vertical alignment application

After selecting the application the list of projects is displayed.

The station does not have to be set for this application.

Measurements to the 1st reference point

The angle and distance are measured to the 1st reference point.

The distance can be measured directly to the point or using the reflector rod, depending on ease of access to the 1st reference point.

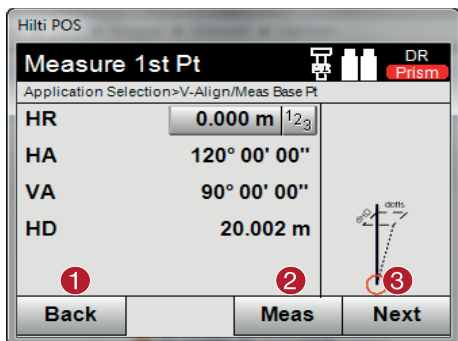

- ① Return to project selection
- ② Measure angle and distance to the 1st reference point
- ③ Continue to the next measurement

Measuring to other points

The other points are always determined by taking angle and distance measurements.

After the second and each further measurement, the correction values compared to the 1st reference point are updated in the display below.

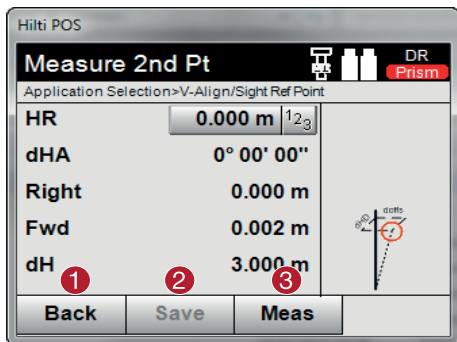

- ① Return to "Measuring to the first reference point"
- ② Save results
- ③ Measure angle and distance and update correction values in the display

en

10.13 Plan & Points

With the aid of the "Plan & Points" application you can quickly and easily extract points from imported CAD files, create new points/lines or delete existing ones. All points/lines necessary for work in the field can thus be quickly and easily created on the spot from CAD files, and edited.

NOTE

Only files in the .dxf format can be imported. Files in the .dwg or other formats cannot be imported.

10.13.1 Starting an application

To start the "Plan & Points" application, press the "Plan & Points" button in the main menu.

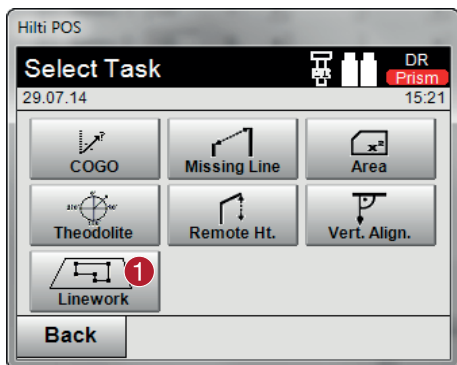

- ① Selecting the "Plan & Points" application

10.13.2 Overview

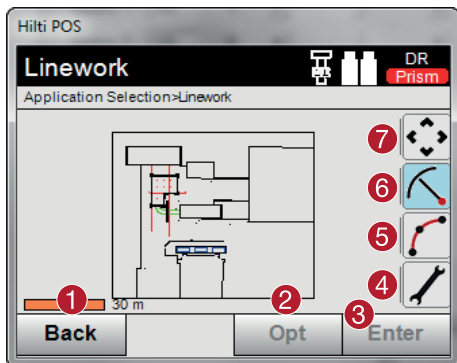

- ① Return to previous dialog
- ② Set parameters
- ③ Confirm dialog
- ④ General settings
- ⑤ Drawing
- ⑥ Extract points
- ⑦ Zoom function

10.13.2.1 Using the buttons in “Plan & Points”

In the “Plan & Points” application, the buttons positioned at the right-hand edge of the screen can be used to open further screens. These buttons differ from the other buttons and can be used in two ways:

- Press the button for at least a second
- Press the button and then swipe to the left

10.13.2.2 General settings

The “General settings” button makes the following functions available:

- Layer manager
- Activate / deactivate DXF
- “Info” dialog

10.13.2.3 Drawing

The “Draw” button makes the following functions available:





- Curve with 3 points
- Curve with 2 points and a radius
- Straight line with 2 points

10.13.2.4 Extracting points

The “Extract points” button makes the following functions available:

- Points with and without an offset
- Center points of circles
- Division of a line or line segment
- Creating an intersection
- Deleting points
- Manual mode

10.13.3 Extracting / creating points

	Creates the center point of a radius or curve
	Creates offset points
	Divides a segment of a line or a whole line into sections of equal length
	Creates the intersection of 2 intersecting lines
	Deletes selected points
	Free selection of points
	Draws a curve comprising 3 points
	Draws a curve comprising 2 points and a radius
	Creates a line between 2 points

10.13.3.1 Creating offset points

This function lets you enter the point number, longitudinal value and transverse value.

10.13.3.2 Dividing a line or a segment of a line

A segment of a line or a whole line can be divided into sections of equal length.

- The first click selects the whole line.
- The second click selects the segment of the line.
- The third click cancels the selection.

10.13.3.3 Creating a point from a line intersection

Two or more lines that intersect at a point are selected. A new point is created at the intersection. The intersection has no height information.

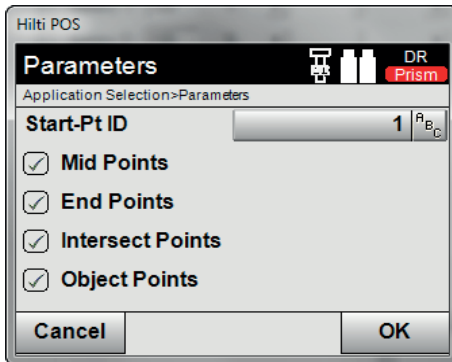

10.13.3.4 Free selection of points





en

This setting lets you define which points are to be extracted.

10.13.4 Drawing

	Draws a curve comprising 3 points
	Draws a curve comprising 2 points and a radius
	Creates a line between 2 points

10.13.5 General settings

	Settings
	Layer settings
	Displays all relevant information about the selected object

10.13.5.1 Layer settings

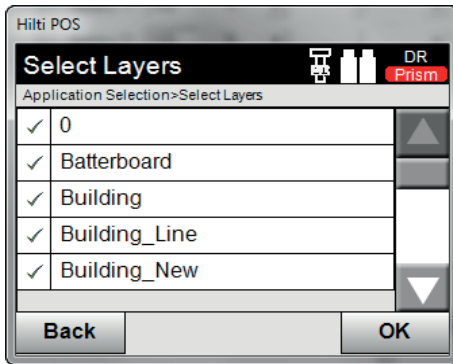

This setting activates or deactivates individual layers.

NOTE

It is not possible to edit or remove layers from an imported .dxf file.

10.14 Activating data exchange with design applications

10.14.1 Procedure with the PROFIS Connect application

NOTE

Version 2.2.0 and higher of the total station application software also includes the PROFIS Connect application. If the version number of your total station application software is lower than 2.2.0, please contact your Hilti representative.

The “PROFIS Connect” application lets you record and lay out points through dynamic exchange of coordinates with a design application installed on a PC connected to the total station. The coordinates of newly measured points can be transferred from the total station to the design application and existing point coordinates can be transferred from the design application to the total station.

1. PROFIS Connect start dialog

- To start the “PROFIS Connect” application, simply click “PROFIS Connect” in the main menu.

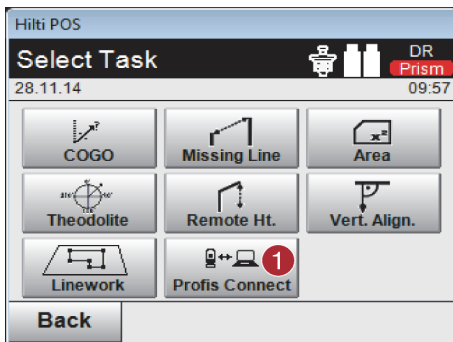

- ① Activating data exchange with Hilti PROFIS Connect

2. Selecting the application to be used for data exchange

- Select the application for which you wish to activate data exchange.

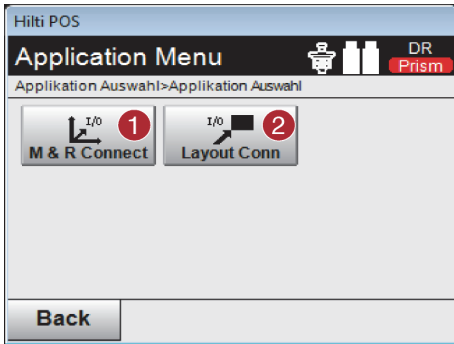

- ① Start the “Measure & Record” application with data exchange. Points are transferred from the total station to the design application on the PC.

- ② Start the “Layout” application with data exchange. Points are transferred from the design application on the PC to the total station.

11 Data and data handling

11.1 Introduction

Hilti total stations always save data in internal memory.

The data consists of measured values, i.e. angles and distances or, depending on settings or the application, values relative to the building control line such as line and offset values or coordinates.

With the aid of PC software, data can be exchanged with other systems.

In principle, all total station data should be regarded as point data, with the exception of graphical data in which the points are incorporated.

The applicable points are available for selection and use, but not the graphics data itself, which simply provides additional information.

11.2 Point data

Point data can consist of new measured points or existing points. The total station basically measures angles and distances.

The station setup allows target point coordinates to be calculated.

Accordingly, each point that has been sighted with the cross hairs or laser pointer and the distance to it measured is calculated by the total station as a **three-dimensional point**.

These three-dimensional points are clearly identified by point designations.

A point designation, a Y-coordinate, an X-coordinate and possibly a height are given for each point.

Given points are defined by their coordinates or points with graphical elements.

11.2.1 Points in the form of measured points

Measurement data takes the form of measured points generated and saved in memory as coordinate points on the total station by the relevant application, e.g. Horz. Layout, Vert. Layout, As-built and Measure and Record.

Measured points exist only as a single instance within a station.

If the same name is used again for a measured point, the existing measured point can be overwritten or another point name assigned to it.

Measured points cannot be edited.

11.2.2 Points in the form of coordinate points

When working with the coordinate system, all positions are, as a rule, defined by a point name and coordinates - at least a point name and two horizontal coordinates X, Y or E, N are necessary to describe a point position.

The height is generally independent of the XY coordinate values.

The total station uses points in the form of coordinate points - so-called control points or fixed points and measured points with coordinates.

Fixed points are points with given coordinates, which are entered manually on the total station or transferred from USB memory or directly by way of a USB cable with the aid of Hilti PROFIS Layout.

These fixed points may also be layout points. A control point (fixed point) in a project is unique (the only one).

Control points or fixed points can be edited on the total station so long as no graphical element is attached to the point.

11.2.3 Points with graphical elements

With the aid of Hilti PROFIS Layout, graphical data can be transferred from a CAD environment, shown on the screen and selected for use.

The Hilti system allows points and graphical elements to be created in various ways using Hilti PROFIS Layout, and to subsequently transfer these to the total station for further use.

Points with attached graphical elements cannot be edited on the total station but can be edited on a PC using Hilti PROFIS Layout.

11.3 Generation of point data

11.3.1 With the total station

Each measurement taken generates a measurement data set or, respectively, a measured point. Measured points are defined either only as angle and distance values, point name with angle and distance values or as point name with coordinates.

11.3.2 With Hilti PROFIS Layout

1. Generating points from a model consisting of lines and curves shown with graphical elements

With the PC application Hilti PROFIS Layout, dimensions from the building plan can be used to generate a graphical layout which is a reproduction, so to speak, of the building plan.

With the aid of this application, the plan is reproduced in simplified graphical form on the PC, resulting in lines and curves, etc. on a graphical background.

In doing so, specific curves can be created, from which points can be generated, e.g. at regular intervals.

2. Generating points from imported CAD and CAD-compatible data

With the aid of **Hilti PROFIS Layout** CAD data in the DXF or AutoCAD-compatible DWG format can be transferred to a PC.

Points are then generated from the graphical data, i.e. lines, curves etc.

Hilti PROFIS Layout offers the possibility of using CAD graphics to generate point data from end points, line intersections, mid points of line segments and points on circles, etc.

The point data generated in this way is placed visibly on the original graphics elements from CAD.

The data in a CAD format can exist in various "layers". When this data is transferred to Hilti PROFIS Layout it is merged into a single layer.

NOTE

When organizing the data on the PC before it is transferred to the tool, special care must be taken to ensure that the "density" of the point data is as to be expected in the final result.

3. Importing data from tables or text files

Point data can be imported into Hilti PROFIS Layout from text or XML files and then transferred to the total station.

11.3.3 With Hilti Point Creator

The software Hilti Point Creator is a plug-in that can be installed in AutoCAD from version 2010. Hilti Point Creator is used to extract points with coordinates from 2D and 3D drawings. In addition, descriptions (attributes) for these positions are taken from the AutoCAD 2D/3D model. The attributes are taken from Hilti products - see the Hilti BIM/CAD library. For Hilti products, the Hilti product item number, product designation and product type are taken. In addition, more general attributes are taken, for example layer name and color of the graphic element in the AutoCAD model.

Point data can be created directly from 2D or 3D CAD models. This point data is exported from the AutoCAD software with the help of the Hilti Point Creator in various formats.

Hilti Point Creator – output formats for points

- Text format with attributes (*.txt)
- Excel format with attributes (*.csv)
- CAD format; only points without attributes (*.dxf)
- Hilti data format with attributes (*.oml)

11.4 Data memory

11.4.1 Total station internal memory

The Hilti total station saves and organizes application data correspondingly in memory.

Point or measurement data is organized in the system according to projects and stations.

Project

A single block of control points (fixed points) or layout points belongs to a project.

A number of stations may belong to a project.

Tool station plus orientation (where relevant)

A station must always have an orientation.

Measured points with unique point designations belong to a station.

NOTE

A project can be regarded as a file, so to speak.

11.4.2 USB memory

USB memory allows data to be transferred between a PC and the total station. It is **not** used as additional main memory.

NOTE

The total station's internal memory is always used as its active main memory.

12 Total station data manager

12.1 Overview

The Data Manager provides access to the data stored internally.

Options for the data manager:

- Import and export **data**
- Display, create, delete **projects**
- **Points**
Display, create, delete, edit fixed points
Display, delete measuring points
- Display, create, delete **graphic**, edit graphic elements such as lines, curves

12.2 Procedure for “Data manager” application

Access to data management is directly from the start screen.

1. “System” starting dialog

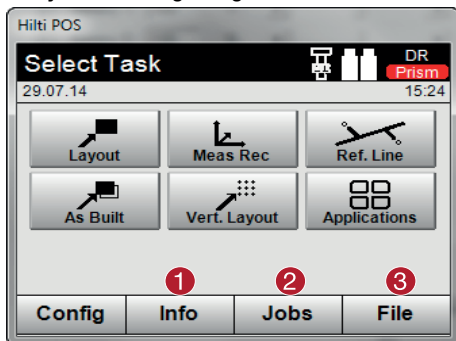

- ① Information about the project
- ② Select the Project Manager
- ③ Select import / export manager

2. “Info” starting dialog

- **Import/export manager** (Import/export of point data)
- **Project manager** (Display, create, delete project settings)
- **Point manager** (Display, create, delete, edit fixed points plus display, delete measuring points)
- **Graphic manager** (Display, create, delete lines and curves)

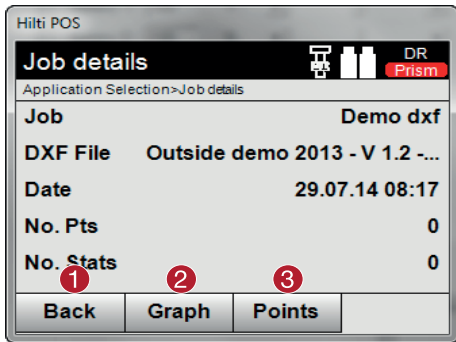

- ① Return to previous dialog

- ② Select Graphic Manager

- ③ Select Point Manager

12.2.1 Import / export manager



- ① Return to previous dialog

- ② Confirm copying of data in the internal memory

- ③ "Copy data" option

- ④ Import data setting

- ⑤ Export data setting

- ⑥ Import .dxf file

12.2.1.1 Importing points

This setting is used to load data from the connected USB data storage device directly into the selected project. All points with coordinates are imported as fixed points, i.e. the points can be used for positioning, setting out and for the graphics (lines, curves). During the import process, the point numbers of the points are compared with the point numbers that already exist in the project.

As each point number can only occur once as a fixed point within a project, the following four options are available where point numbers are the same:

Selection options for identical point numbers

- Do **not** overwrite individually existing selected points
- Overwrite individually existing selected points
- Do **not** overwrite all existing points
- Overwrite all existing points

Data can be imported in the file format *.csv or *.txt. The individual data elements must exist in the previously named sequence. The following elements are imported as fixed point data in this sequence: Pt. no., N(X), E(Y), H(Z), Attributes 1 -5.

NOTE

Points that do not exist in the project are imported without any additional messages. If further elements still exist following the specified imported elements, these are ignored.

12.2.1.2 Exporting points

With the export function, all points of a project are exported to a connected USB data storage device, and all points are seen as being the same. The name of the export file can be entered as required.

The exported data elements vary, depending on the type of points in a project:

- Export fixed points with: Pt. no., N(X), E(Y), H(Z), Attributes 1 – 5
- Export measuring points with: Pt. no., N(X), E(Y), H(Z), Attributes 1 – 5, HA, VA, HD, hr, ppm

NOTE

A clear name must be assigned to each file of a file type. If the same name is entered again for a file of the same type, the existing file will be overwritten, i.e. deleted.

en

NOTE

By exporting and re-importing measuring points, measuring points can be converted into fixed points.

12.2.1.3 Internal copying of data

This setting can be used to duplicate a project in the internal memory. All project data is then saved under a new name.

12.2.1.4 Importing / attaching a .dxf file

This option lets you import a .dxf file into a project or attach it to a project.

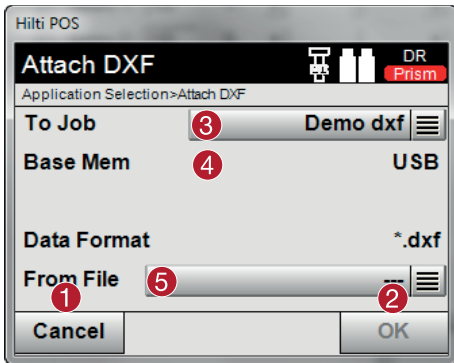

- ① Cancel the dialog

- ② Confirm the dialog

- ③ Select a project

- ④ Select the memory device

- ⑤ Select the file to be imported

12.2.2 Project manager

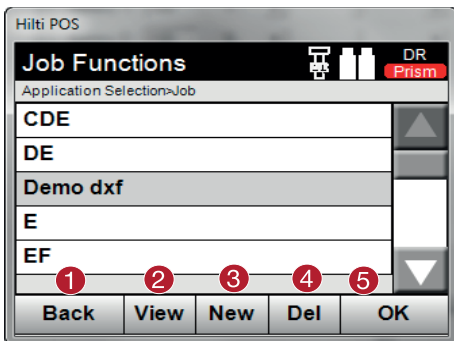

- ① Return to Data Manager starting dialog

- ② Project information

- ③ Set up new project

- ④ Remove project

- ⑤ Set marked project as current project

12.2.3 Point manager



- ① Return to data manager start dialog
- ② Fixed points setting
- ③ Measuring points setting
- ④ Display all points setting

en

12.2.3.1 Fixed points

Fixed points can be displayed, deleted, edited and re-entered. When new fixed points are entered, in addition to the point numbers and coordinates, up to an additional 5 descriptions (attributes) can also be entered.

Data elements of fixed points

- Point no.
- N
- E
- H(Z)
- Attributes 1 – 5

NOTE

Fixed points which have a graphic element assigned to them, e.g. line, curve etc., can only be deleted when the graphic element has been deleted.

12.2.3.2 Measured points

Measuring points are always assigned to a station. Once a station has been selected, all measuring points for this station can be displayed and deleted.

Options for deleting measuring points

- Each measuring point can be individually deleted once the station is selected
- All measuring points can be deleted at the same time by deleting the station

NOTE

Particular care should be taken when deleting measuring points. For example, if a station is deleted and therefore all the attached measuring points, many measuring hours or a day's work can be lost.

Data elements of measuring points

- Pt. no.
- N
- E
- H(Z)
- Attributes 1 – 5
- HA
- VA
- HD
- hr
- ppm

NOTE

For a selected measuring point, the assigned attributes can be displayed from the application "Measure and Record".

Measuring points can be used for setting the station and orientation, but not for assigning graphic elements, for example lines and curves for the "Reference line" application.

12.2.3.3 Display all points

All fixed points and all measuring points are displayed here, sorted according to point number, with the corresponding type description (fixed point or measuring point). The points can be displayed in a graphic, in a list or one after the other.

Point types for the display:

- Fixed points
- Measured points
- Stations

12.2.4 Graphic manager

The graphic manager displays all points and graphic elements. The display can be moved and made larger. The graphic elements, such as lines and curves, are used in the reference line application.

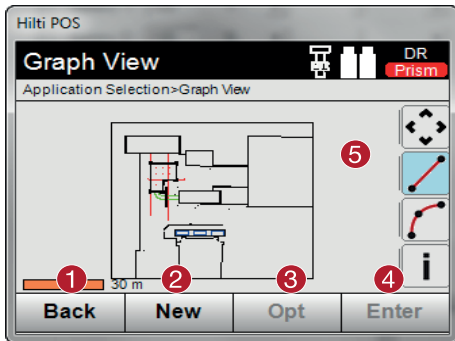

- ① Return to previous dialog
- ② Function for creating new elements
- ③ Parameter settings
- ④ Confirm dialog
- ⑤ Functions for zooming, creating lines and curves, ...

12.2.4.1 Delete graphic element

Graphic elements can be marked by "tapping" on them. The marked graphic element can then be deleted using the delete button.

12.2.4.2 Create graphic element

Graphic elements, for example lines and curves, can be created here for the reference line application, with the advantage that they can be selected quickly in the application.

Graphic elements that can be entered:

- Line with 2 points
- Curve with 2 points plus radius
- Curve with 3 points

NOTE

The points can be selected using only fixed points and only from the graphic point display or point list.

13 Exchanging data with a PC

13.1 Introduction

Data exchange between the total station and a PC is always via the PC application Hilti PROFIS Layout.

The data is exchanged in binary format and cannot be read without these applications.

Data can be exchanged using either the USB data cable supplied or a USB memory device (e.g. flash drive).

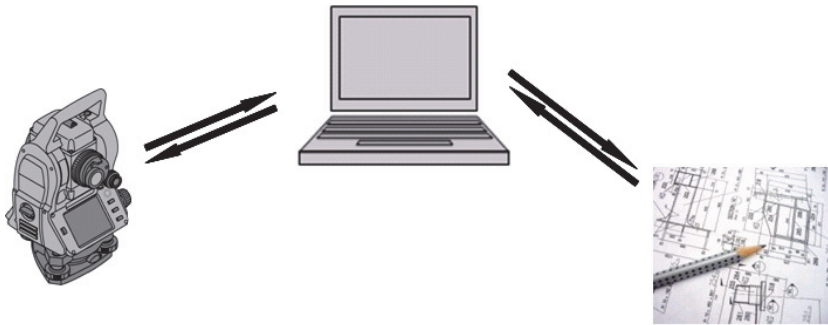

13.2 HILTI PROFIS Layout

Data is always exchanged as a complete project, i.e. all data belonging to a project is exchanged between the Hilti total station and **Hilti PROFIS Layout**.

A project may contain only control points or fixed points, with or without graphics, or a combination, i.e. control points or fixed points and measured points (measurement data) including results from the corresponding applications.

13.2.1 Data types

Point data (control points or layout points)

Control points are, at the same time, also layout points, to which graphical elements can be attached in order to facilitate identification or to describe the situation.

If these points with graphical elements are transferred from a PC to the total station, then this data will be displayed with graphics on the total station.

If control or layout points are entered manually on the total station at a later point in time, no graphical elements can be assigned or added to these on the total station.

Measurement data

Measured points or, respectively, application results can always only be transferred from the total station to **Hilti PROFIS Layout**.

The measured points transferred can take the form of point data in space-separated or comma-separated value (CSV) text format or in other formats such as DXF and AutoCAD DWG for further use on other systems.

The output of application results such as layout differences, area calculations, etc. from **Hilti PROFIS Layout** can take the form of reports in text format.

Summary

The following data can be exchanged between the total station and Hilti PROFIS Layout.

From the total station to Hilti Profis Layout:

- Measurement data: Point name, angle and distance
- Point data: Point name, coordinates and height.

From Hilti Profis Layout to the total station:

- Point data: Point name, coordinates and height.
- Graphics data: Coordinates with graphical elements.

NOTE

No provision has been made for direct data exchange between the total station and other PC systems, this can be done only by using Hilti PROFIS Layout.

13.2.2 Hilti PROFIS Layout data output (export)

Data is saved in the following applications and can be exported with the aid of Hilti PROFIS Layout in various formats:

1. Horizontal layout
2. Vertical layout
3. As-built
4. Measure and record
5. Area measurement (calculation)

en

Data output

Hilti PROFIS Layout reads the data saved by the total station and extracts the following data.

1. Point name, horizontal angle, vertical angle, distance, reflector height, tool height
2. Point name, E(Y) coordinate, N(X) coordinate, height
3. Application results such as differences in layouts and area measurements

Output formats

CSV format	Comma-separated values.
Text format	Gaps between data filled with spaces so that individual data items appear in columns.
DXF format	Text exchange format compatible with CAD.
DWG format	Binary data format compatible with AutoCAD.

13.2.3 Hilti PROFIS Layout data input (import)

Data input

Using Hilti PROFIS Layout, the following data can be read, converted and transferred to the total station directly by cable or on a USB memory device:

1. Point names (fixed points) with coordinates and heights.
2. Polylines (lines, curves) from other systems

Input formats

CSV format	Comma-separated values.
txt format	Space-separated values.
Text format	Gaps between data filled with spaces so that individual data items appear in columns.
DXF format	CAD drawing with lines and curves as general CAD data exchange format.
DWG format	CAD drawing with lines and curves as data exchange format compatible with AutoCAD.

13.2.4 Review of Hilti Point Creator functions

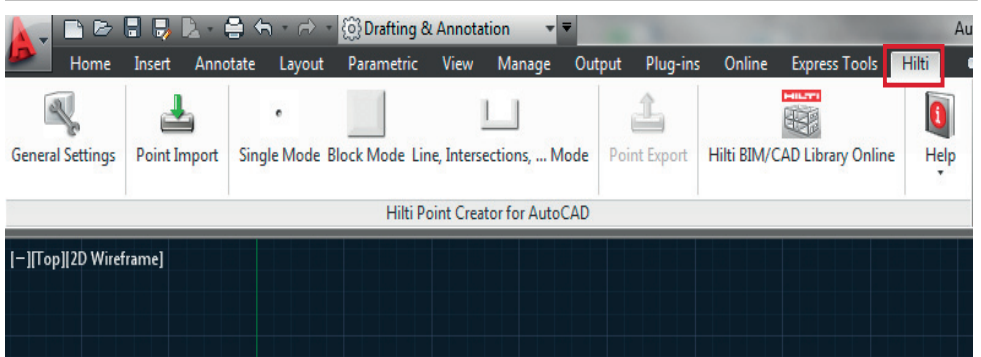

The Hilti Point Creator offers the following functions:

Settings

- General settings

Data import

- Imports points according to the settings from various data formats.

Point selection methods

- Single mode
Determines points using the AutoCAD capture function
- Block mode
Takes points from blocks. These points are first “learned” in a reference block
- Line mode
Determines points from elements such as lines or curves. The points are determined either from their ends or middle or from the intersection of curves and lines, the intersection of lines with lines or from the intersection of curves with curves.

Data export

- Exports the extracted points in accordance with the settings in various output formats.

Link to the Hilti BIM/CAD Library

- Loads Hilti BIM/CAD objects from the Internet and inserts them into the AutoCAD or Revit or other design software.

The created points with attributes are assigned a point designation. These are copied on a layer defined by the operator (“Hilti” is standard) and can be output in various data formats.

Help

- Displays Help texts and information about the program version.

Hilti Point Creator output formats for points

- Text format with attributes (*.txt)
- Excel format with attributes (*.csv)
- CAD format - only points without attributes (*.dxf)
- Hilti data format with attributes (*.oml)

Typical data created by Hilti Point Creator (*.txt, *.csv):

PtID	N(x)	E(y)	Height	Layer	Item No	Naming	Element	Color
Ins_1	2024.597	72.509	3.056	Pipe 15	285927	HIL-23	INSERT	white
Ins_2	2020.597	72.509	3.056	Pipe 15	285927	HIL-24	INSERT	white
Ins_3	2016.597	72.509	14.234	Pipe 16	285927	HIL-25	INSERT	white
Ins_4	2012.597	72.509	14.230	Pipe 17	285927	HIL-26	INSERT	white
Ins_5	2008.597	72.509	14.000	Pipe 18	285927	HIL-27	INSERT	white
Ins_6	2004.597	72.509	1.002	Water	285927	HIL-28	INSERT	white
Ins_7	2004.245	73.371	1.100	Water	285927	HIL-29	INSERT	white
Ins_8	2004.245	75.772	1.345	Water	285927	HIL-30	INSERT	white
REF_1	2025.837	72.89	1.632	Control Pts		Inside Ref	Ref_Tape	black
REF_2	2002.445	77.59	1.724	Control Pts		Inside Ref	Prism	black
REF_3	1971.17	71.918	1.773	Control Pts		Inside Ref	Ref_Tape	black

13.3 Overview of functions provided by the PROFIS Connect application

The “PROFIS Connect” application lets you record and lay out points through dynamic exchange of design data with a design application installed on a PC connected to the total station.

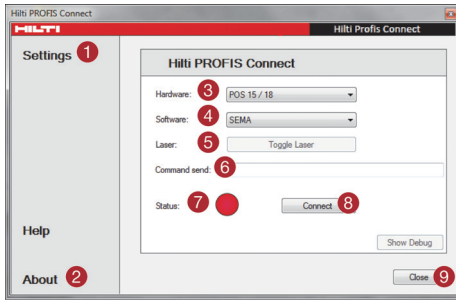

- ① Communication settings for connecting the total station to the PC

- ② Information about the current version

- ③ Selecting the total station

- ④ Selecting the design application with which data is to be exchanged

- ⑤ Switching the laser on/off provides easy indication of an active connection between Hilti PROFIS Connect and the total station

- ⑥ Coordinate data display. The format of the coordinate data is adapted according to the selected design application (e.g. Sema, Dietrich, etc.). The information is visible only when the option "Command sequence" has been activated under "Settings".

- ⑦ Status of the current connection between the total station and the design application: Green: The total station and the design application are connected. Red: No connection

- ⑧ Making a connection between the total station and the planning application

- ⑨ Ending the application

Settings

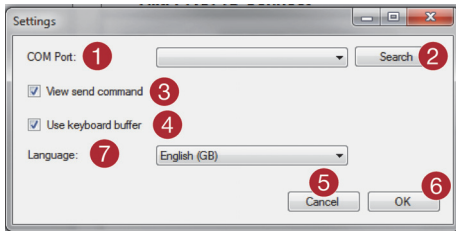

- ① Selecting the communication interface (COM port) to which the total station is connected

- ② Using the "Search" button to find the COM port to which the total station is connected

- ③ Viewing data from the command sent

- ④ Transferring point coordinates to the keyboard buffer memory

- ⑤ Canceling the dialog

- ⑥ Confirming the dialog

- ⑦ Selecting the language

14 RS 232 interface for data transfer

The Hilti total station is equipped with an RS 232 interface to which a data logger can be attached for data transfer. Please contact your Hilti representative for further information.

15 Calibration and adjustment

15.1 In-the-field calibration

The total station calibration function (in-the-field calibration) enables the operator to check the tool and to adjust the tool parameters electronically.

The tool is correctly adjusted when supplied.
 The values to which the tool is set may change over time or due to temperature fluctuations, transport or aging. The tool therefore incorporates a feature that allows the settings to be checked and, if necessary, corrected by carrying out in-the-field re-calibration.

This is done by setting up the tool securely on a tripod of good quality and targeting an easily visible, clearly discernible object within ±3 degrees of horizontal at a distance of approx. 70 – 120 m.

NOTE

After this, follow the instructions on the display.

Interactive instructions for this procedure are shown in the display, so it is simply a matter of following the instructions.

This application calibrates and adjusts the following axes of the tool:

- Target axis
- VA collimation
- Dual-axis compensator (both axes)

en

NOTE

The in-the-field calibration procedure requires great care and each step must be carried out very exactly. Imprecise sighting or vibration of the tool can result in incorrect calibration values, leading to subsequent measurement errors.

NOTE

In the event of uncertainty the tool should be returned to Hilti Service for checking.

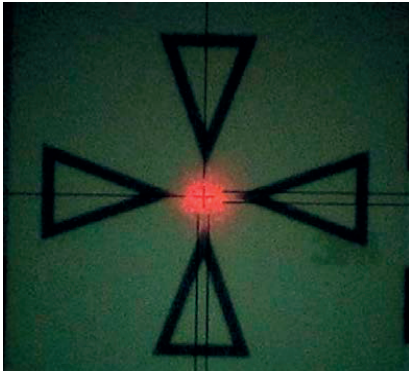
15.2 Checking alignment of the laser point with the cross hairs**To check alignment of the laser spot with the cross hairs, the following steps should be carried out:**

1. Set up the POAW 82 target plate at a distance of about 30 m.
2. Align the cross hairs with the center of the target plate. Aim horizontally, as far as possible.
3. Switch on the laser pointer.
Error in the form of deviation of the laser point from the center of the target plate must be no more than 5 mm (at 30 m).

NOTE

If the error is greater than this, please contact Hilti Service or, respectively, the Hilti Repair Service.

15.3 Procedure for the calibration application**NOTE**

The tool should be operated carefully in order to avoid vibrations.

NOTE

The in-the-field calibration procedure requires great care and each step must be carried out very exactly. Imprecise sighting or vibration of the tool can result in incorrect calibration values, leading to subsequent measurement errors.

NOTE

In the event of uncertainty the tool should be returned to Hilti Service for checking.

Preparing for calibration

1. Set up the tool in a steady, secure position on a good tripod.
2. Select "Configuration" from the application menu.

1. "System" start dialog

- Use the **Config** button to select the data manager

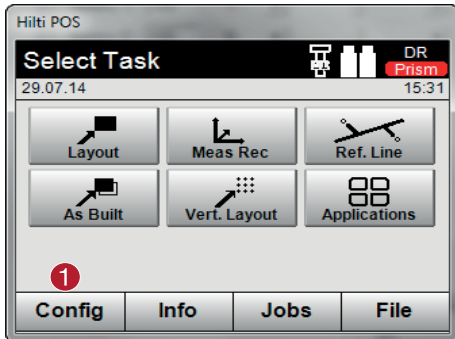

- ① Start configuration

2. "Configuration" start dialog

- Start calibration in the configuration menu

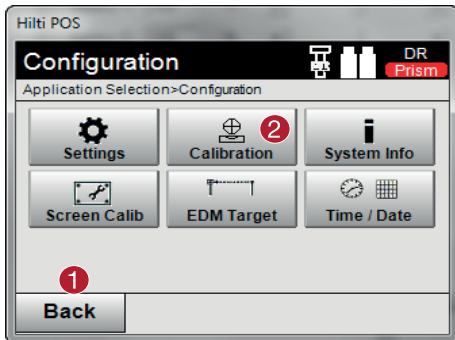

- ① Return to "System" dialog
- ② Start calibration

In the following sections, the sequence and procedure for the various calibrations are outlined.

15.3.1 Calibrating the target axis error and VA collimation error

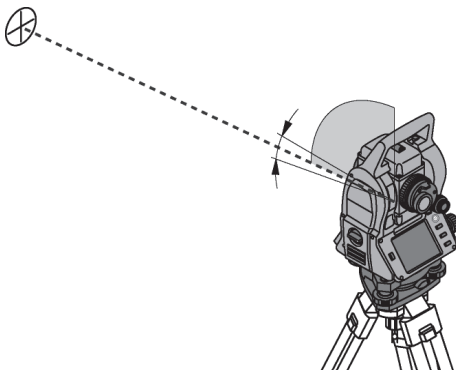

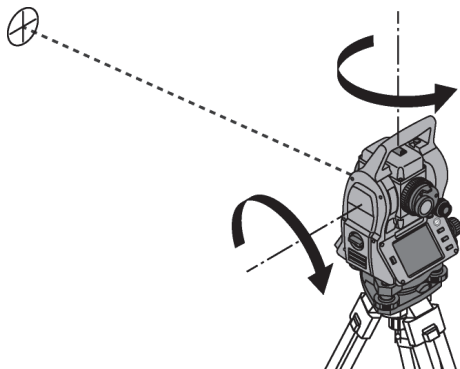

The target axis error is the deviation of the optical sighting (target axis) from the mechanical / optical telescope axis. The VA collimation error is the deviation of the “zero direction” of the vertical circle from the mechanical vertical axis. This calibration is essential for safe and precise height measurements.

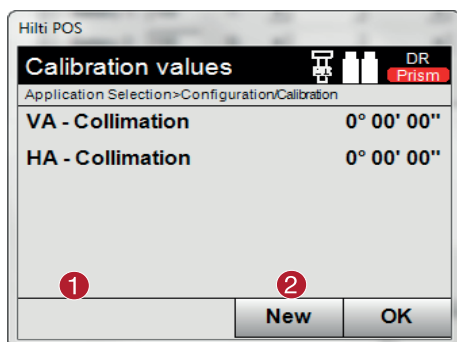

-
- ① Return to previous dialog
-
- ② Initiate measurement
-

Procedure

1. Begin calibration of the horizontal and vertical axes. Follow the instructions displayed on the screen.
2. With the telescope in position I, carefully line up the cross hairs on the selected target and follow the instructions displayed on the screen.
3. After taking the measurement, change to position II.
4. With the telescope in position II, carefully line up the cross hairs on the selected target and follow the instructions displayed on the screen.
5. The total station calculates and displays the new correction values.
6. Decide whether you want to use the new values or keep the “old” calibration values.

15.4 Hilti Repair Service

The Hilti Repair Service checks the tool and, if deviations from the specified accuracy are found, recalibrates it and checks it again to ensure conformity with specifications. The service certificate provides written confirmation of conformity with specifications at the time of the test.

Recommendation

- Have the tool checked at suitable intervals, depending on how heavily it is used.
- Have it checked by the Hilti Repair Service at least once a year.
- After exceptionally heavy use or rough treatment, have the tool checked by the Hilti Repair Service.
- The tool should be checked by the Hilti Repair Service before being used for particularly important work.

Having the tool checked by the Hilti Repair Service does not relieve the user of his/her obligation to check the tool before and during use.

16 Care and maintenance

NOTE

Have damaged parts replaced by Hilti Service.

16.1 Cleaning and drying

Blow any dust off the glass.

CAUTION

Do not touch the glass surfaces with your fingers.

Use only a soft, clean cloth to clean the tool. If necessary, the cloth may be moistened with a little pure alcohol or water.

CAUTION

Do not use liquids other than alcohol or water. Other liquids may damage plastic parts.

NOTE

Have damaged parts replaced by Hilti Service.

16.2 Storage

NOTE

Do not put the tool into storage when wet. Allow it to dry before putting it away.

NOTE

Always clean the tool, its transport container and accessories before putting them into storage.

NOTE

Check the accuracy of the equipment before it is used after a long period of storage or transportation.

CAUTION

Remove the batteries if the tool is to remain unused for a long period of time. Leaking batteries may damage the tool.

NOTE

Observe the specified temperature limits when storing your equipment, above all in winter and summer, especially if the equipment is stored in a motor vehicle (-30°C to +70°C (-22°F to +158°F)).

16.3 Transport

CAUTION

The batteries must be insulated or removed from the tool before the tool is shipped or sent by mail. Leaking batteries may damage the tool.

Use the Hilti shipping box or packaging of equivalent quality for transporting or shipping your equipment.

17 Disposal

WARNING

Improper disposal of the equipment may have serious consequences:

The burning of plastic components generates toxic fumes which may present a health hazard.

Batteries may explode if damaged or exposed to very high temperatures, causing poisoning, burns, acid burns or environmental pollution.

Careless disposal may permit unauthorized and improper use of the equipment. This may result in serious personal injury, injury to third parties and pollution of the environment.



Most of the materials from which Hilti tools or appliances are manufactured can be recycled. The materials must be correctly separated before they can be recycled. In many countries, Hilti has already made arrangements for taking back old tools or appliances for recycling. Ask Hilti Customer Service or your Hilti representative for further information.



For EC countries only

Do not dispose of electronic measuring tools or appliances together with household waste.

In observance of the European Directive on waste electrical and electronic equipment and its implementation in accordance with national law, electrical appliances and batteries that have reached the end of their life must be collected separately and returned to an environmentally compatible recycling facility.



Dispose of the batteries in accordance with national regulations. Please help us to protect the environment.

18 Manufacturer's warranty

Please contact your local Hilti representative if you have questions about the warranty conditions.

19 FCC statement (applicable in US) / IC statement (applicable in Canada)

CAUTION

This equipment has been tested and found to comply with the limits for a class B digital device, pursuant to part 15 of the FCC rules. These limits are designed to provide reasonable protection against harmful interference in a residential installation. This equipment generates, uses and may radiate radio frequency energy. Accordingly, if not installed and used in accordance with the instructions, it may cause harmful interference to radio communications.

However, there is no guarantee that interference will not occur in a particular installation. If this equipment does cause harmful interference to radio or television recep-

tion, which can be determined by turning the equipment on and off, the user is encouraged to try to correct the interference by one or more of the following measures:

- Re-orient or relocate the receiving antenna.
- Increase the distance between the equipment and receiver.
- Consult the dealer or an experienced TV/radio technician for assistance.

NOTE

Changes or modifications not expressly approved by Hilti could void the user's authority to operate the equipment.

20 EC declaration of conformity (original)

Designation:	Total station
Type:	POS 15/18
Generation:	01
Year of design:	2010

We declare, on our sole responsibility, that this product complies with the following directives and standards: 2004/108/EC, 2006/66/EC, 2011/65/EU, EN ISO 12100.

Technical documentation filed at:

Hilti Entwicklungsgesellschaft mbH
Zulassung Elektrowerkzeuge
Hiltistrasse 6
86916 Kaufering
Deutschland

**Hilti Corporation, Feldkircherstrasse 100,
FL-9494 Schaan**

Paolo Luccini
Head of BA Quality and Process Management
Business Area Electric Tools & Accessories
07/2014

Edward Przybyłowicz
Head of BU Measuring Systems
BU Measuring Systems

07/2014

Index

A

AC adapter	6
Adjusting key set	6
Area measurement	4, 76
As-built	3, 56
with prism	3, 56

B

Battery	2, 6, 19, 22
inserting and changing	2, 19

C

Carrying handle	1
Checking functions	2, 19
Configuration	2, 27
Control lines	1, 11
Control panel	2, 20
Coordinates	1, 10
Correction of atmospheric influences	3, 30

D

Data points	2, 18
Data types	4, 95
Display illumination	3, 31
Distance measurement	2, 15
Dual-axis compensator	2, 15

E

Entering points	
Selecting points	2, 18
Eyepiece	1

F

Focussing knob	1
Function buttons	2, 20

Function menu	
FNC	3, 29

G

Guide light	1-3, 18, 29
-----------------------	-------------

H

Height measurement	2, 17
Hilti PROFIS Connect	2, 25
HILTI PROFIS Layout	4, 95
Data input (import)	5, 96
Data output (export)	4, 95
Hilti Repair Service	2, 5, 28, 101
Horizontal circle display	4, 78

Horizontal layout	
with prism	3, 43

I

Inclination indicator	
Vertical	4, 79
Indirect height measurement	4, 80-81
In-the-field calibration	2, 5, 27, 98

L

Laser plummet	1
Laser pointer	2-3, 18, 30
Status indicator	2, 22

M

Measure and record	3, 49
Measuring principle	2, 14
Missing line	4, 73

O

Objective lens	1
--------------------------	---

P

Project	
create new	3, 32
Project information	3, 32
Projects	3, 32

R

Reading the circle	4, 77, 79
Reflector rod	6
POA 50	2, 16
RS 232	5, 98

S

Selecting a project	3, 32
Setting up the tool	2, 23
over a pipe using the laser plummet	2, 24
Showing the active project	3, 32

Software update	
PC software	2, 25
Total station applications	2, 25
Switching the appliance on	2, 23
Switching the tool off	2, 23

T

Targets	2, 16
Telescope positions	2, 12

The tool	
Setting up	2, 24
Theodolite	4, 77
Time and date	2, 27
Total station	6
Switching off	2, 23
Total station applications	
Update	2, 25
Touch screen	
Alphanumerical keyboard	2, 21
Division	2, 20

General operating controls	2, 22
Numerical keyboard	2, 21
Size	2, 20
Tribrach	1

V

Vertical alignment	4, 81
Vertical drive	1

Vertical layout

Vertical layout	3, 59
with building control lines	3, 60
with coordinates	3, 63



Hilti Corporation

LI-9494 Schaan

Tel.: +423/234 21 11

Fax: +423/234 29 65

www.hilti.com

Hilti = registered trademark of Hilti Corp., Schaan
Pos. 1_en | 20141217

